

• **MATERIAIS**

Bases: alumínio
 Testa e Contratesta: Aço Inox

• **MATERIALES**

Bases: alumínio
 Testa e Contratesta: Aço Inox

• **MATERIALS**

Bases: aluminium
 Front plate and wedge : Stainless Steel

• **MATÉRIAUX**

Bases: aluminium
 Têtière et Cache: acier inoxydable

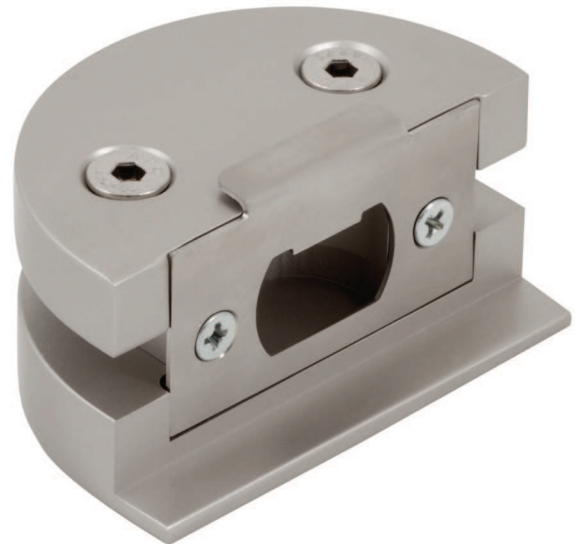

Bases para aplicação de tubulares em portas de vidro.

- Compatíveis com todos os modelos de fechaduras tubulares deste catálogo
- Conceito modular
- Uniformização de solução para vidro e madeira
- Trinco de 80mm
- Espessura do vidro: 10 e 12mm
- Aplicável em portas de 1 ou 2 folhas
- Portas esquerdas e direitas

Bases para aplicación de pomos en puertas de cristal

- Compatibles con todos los modelos de pomos de este catálogo
- Concepto modular
- Solución uniforme para cristal y madera
- Uso exclusivo con picaporte de entradas de 80mm
- Espesor del cristal: 10 y 12mm
- Aplicación en puertas de 1 y 2 hojas
- Reversible para puertas izquierdas y derechas

Bases for tubular sets on glass doors

- Compatible with every tubular knob in this catalogue
- Modular concept
- Unified solution for glass and timber
- Latch of 80mm
- Glass thickness: 10 and 12mm
- Applicable in 1 or 2 leaf doors
- Reversible for left and right doors

Bases pour montage des serrures tubulaires sur portes en verre

- Compatibles avec tous les modèles des serrures tubulaires de cette catalogue
- Concept modulaire
- Solution uniforme pour le verre et le bois
- Utilisation exclusive avec l'entrée de 80mm
- Épaisseur du vitrage : 10 et 12mm
- Application en portes de 1 ou 2 vantaux
- Réversible pour portes gauches et droites

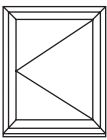

BASES PARA FECHADURAS TUBULARES
BASES PARA POMOS
BASES FOR KNOB LOCKSETS
BASES POUR SERRURES TUBULAIRES



VIDRO MÓVEL
VIDRIO MÓVIL
MOVING GLASS
VERRE MOBILE

VIDRO FIXO
VIDRIO FIJO
FIXED GLASS
VERRE FIXE

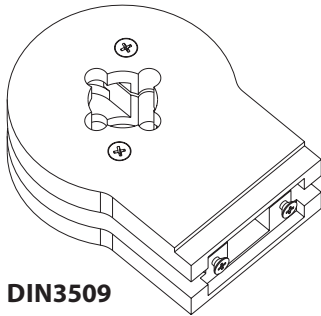

DIN3509

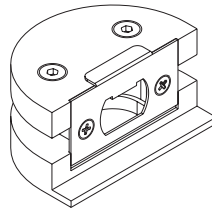

DIN3510

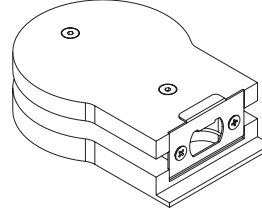

DIN3511

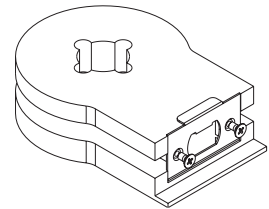

DIN3512

DIN3509

Base longa para vidro móvel.
 Base larga para vidro móvel.
 Long base for moving glass.
 Base longue pour verre mobile.

DIN3510

Base curta para vidro fixo.
 Base corta para vidro fixo.
 Short base for fixed glass.
 Petite base pour verre fixe.

DIN3512

Base longa para puxador duplo.
 Base larga para pomo duplo.
 Long base for double knob.
 Base longue pour poignée double.

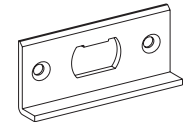

DIN3509/10

DIN3509/10

Contra testa.
 Cerradero.
 Wedge.
 Gâche.

DIN3511

Base longa para vidro fixo.
 Base larga para vidro fixo.
 Long base for fixed glass.
 Base longue pour verre fixe.

OPÇÕES
OPCIONES
OPTIONS
OPTIONS

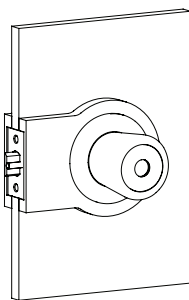

DIN3509

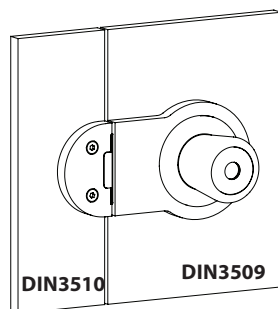

DIN3510

DIN3509

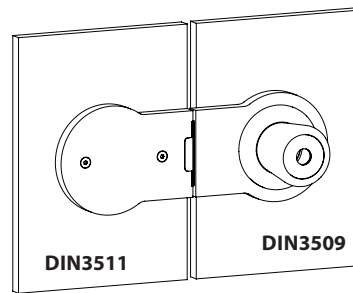

DIN3511

DIN3509

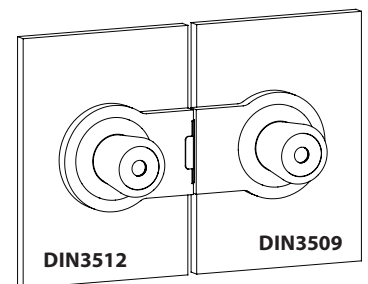

DIN3512

DIN3509

