

[www.dineru.com](http://www.dineru.com)



## SISTEMAS DE ALUMINIO

Banheiros

Divisórias

Rede Mosquiteira

Portões

Roupeiros

Toldos

Pré-Aros

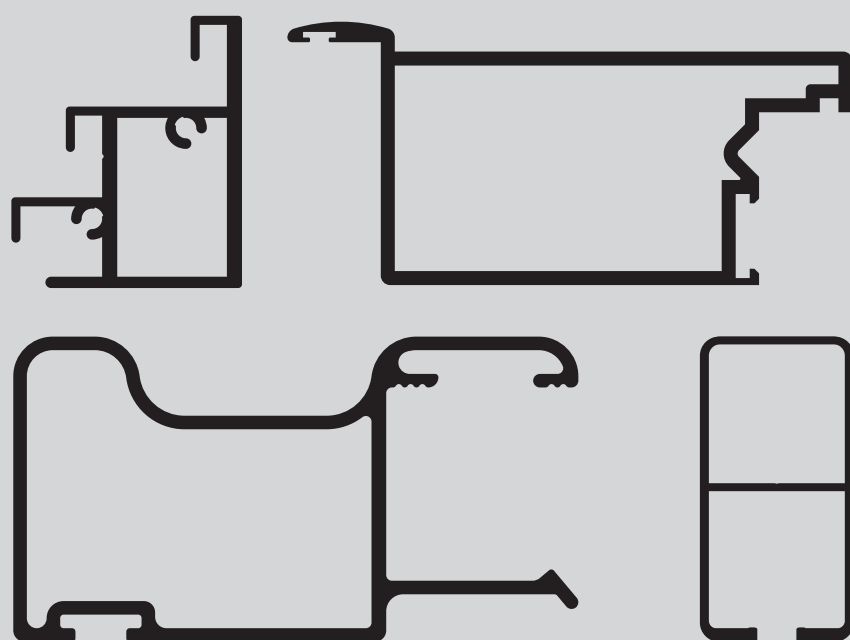

**Perfis  
Standard**



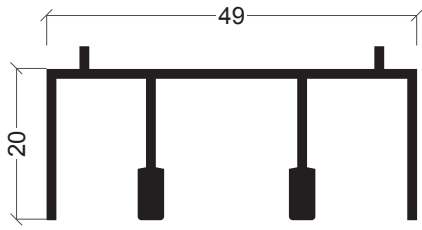

SP-01

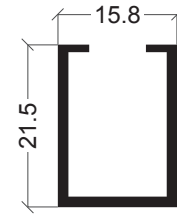

SP-05

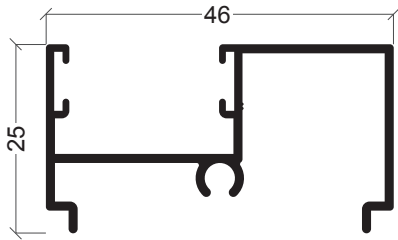

SP-04

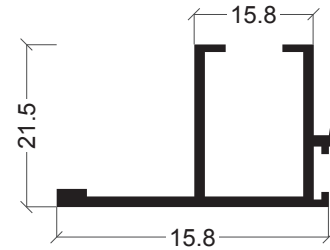

SP-06

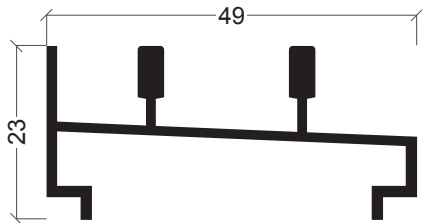

SP-16

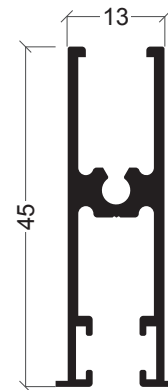

SP-10

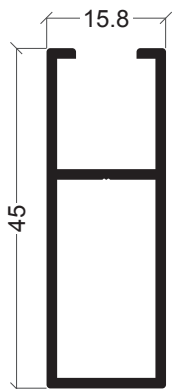

SP-17

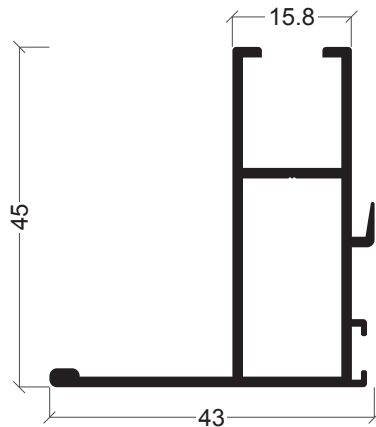

SP-18

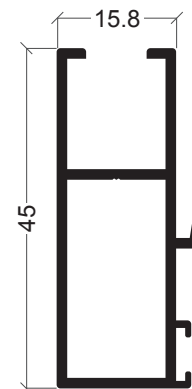

SP-27

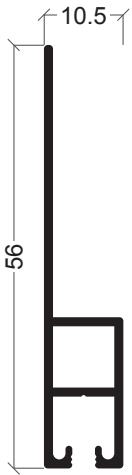

KE-01

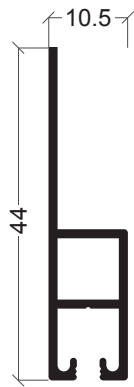

KE-02

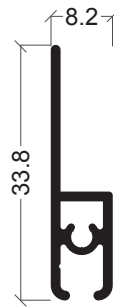

KE-17

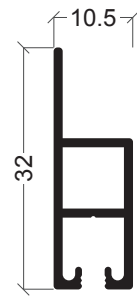

KE-03

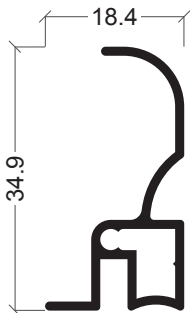

KE-13

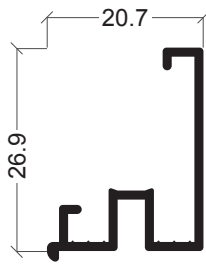

KE-14

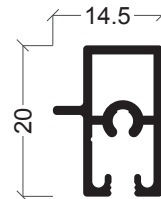

KE-04

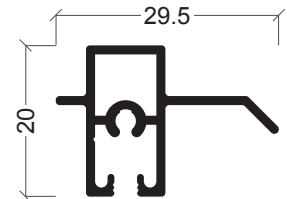

KE-05

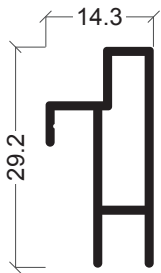

KE-18

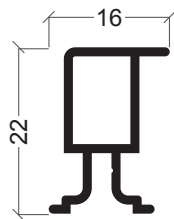

KE-19

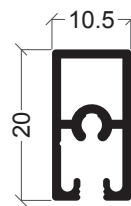

KE-06

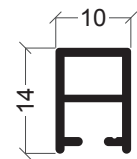

KE-20

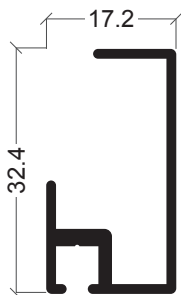

KE-21

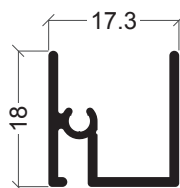

KE-22

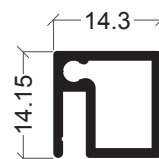

KE-23

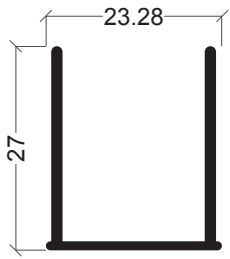

KE-12

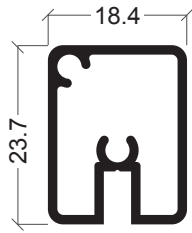

KE-15

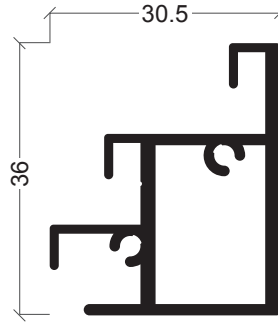

KE-11

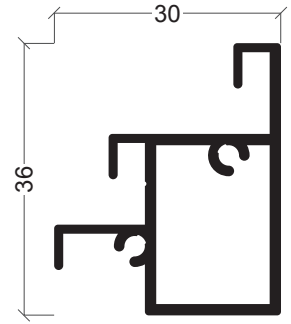

KE-24

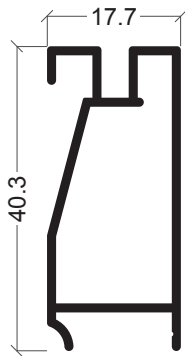

KE-16

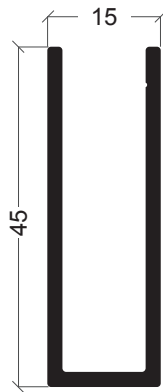

KE-09

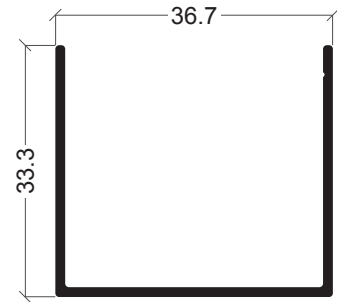

KE-08

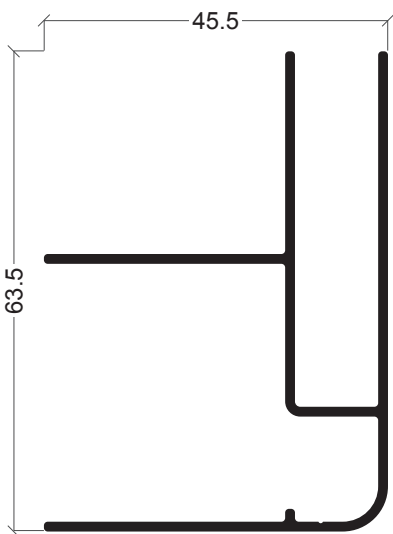

KE-07

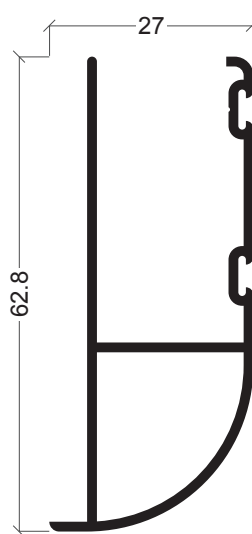

KE-25

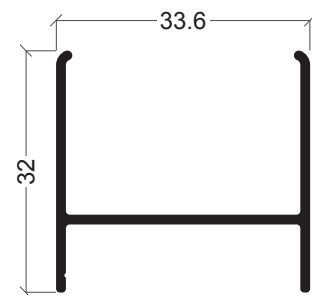

KE-10

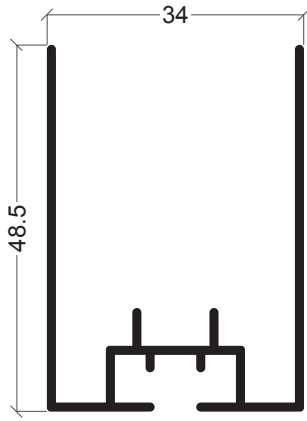

KE-50

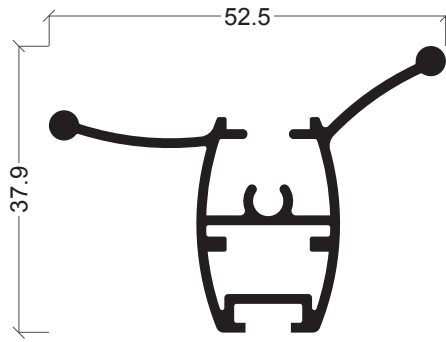

KE-51

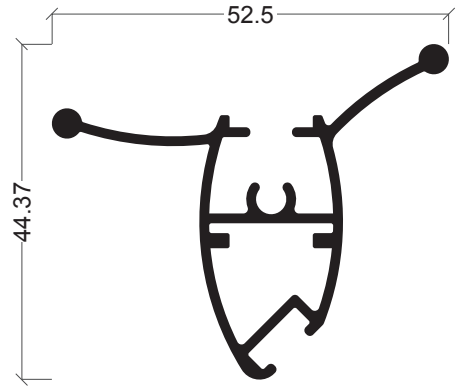

KE-52

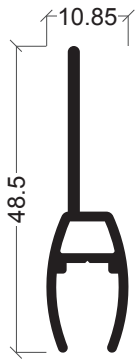

KE-53

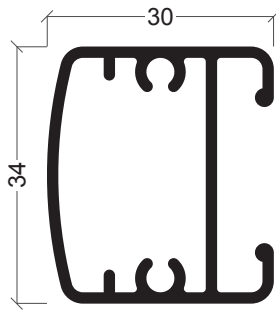

KE-54

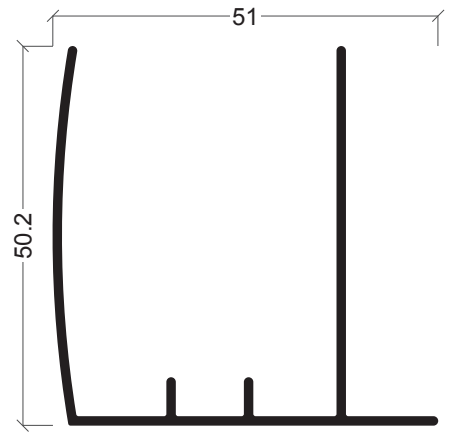

KE-55

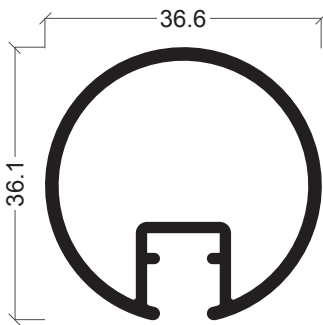

KE-56

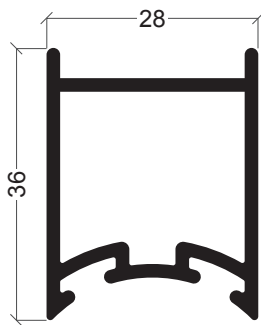

KE-57

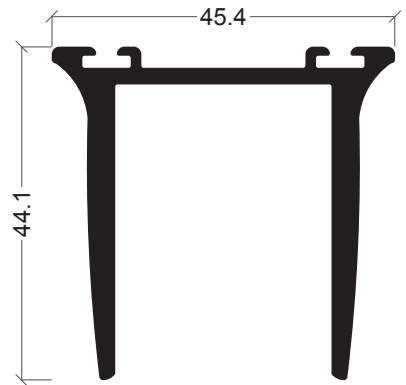

KE-58

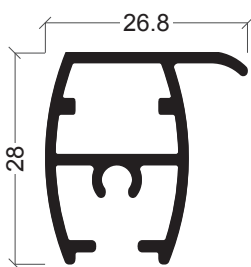

KE-59

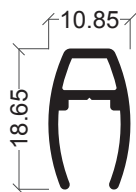

KE-60

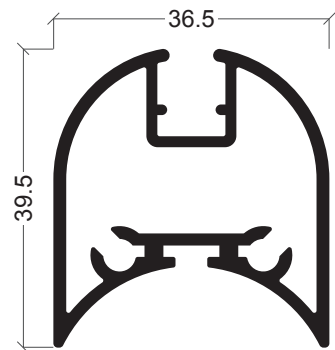

KE-61

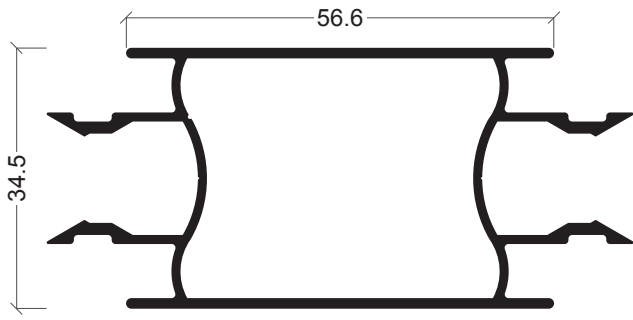

TR-06

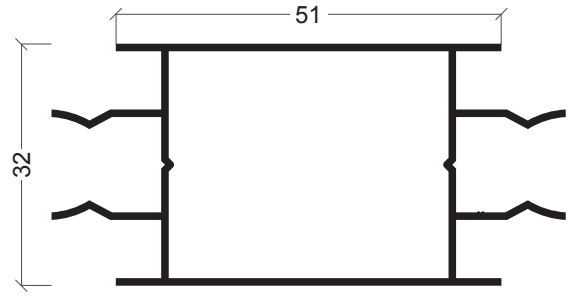

TR-15

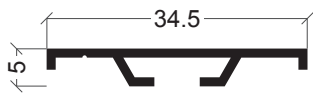

TR-07

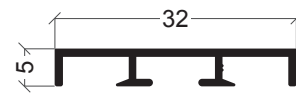

TR-16

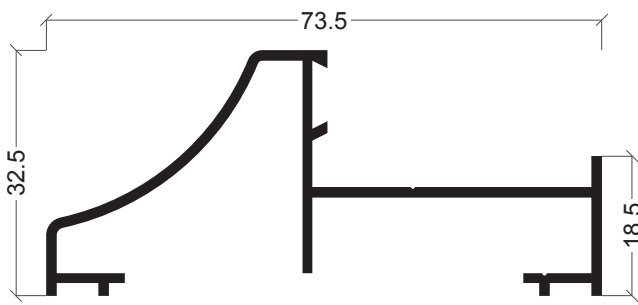

TR-12

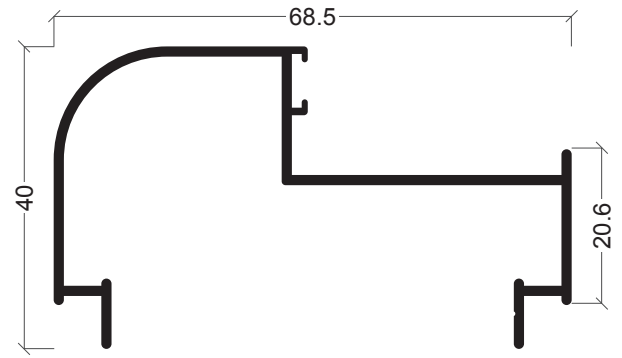

TR-19

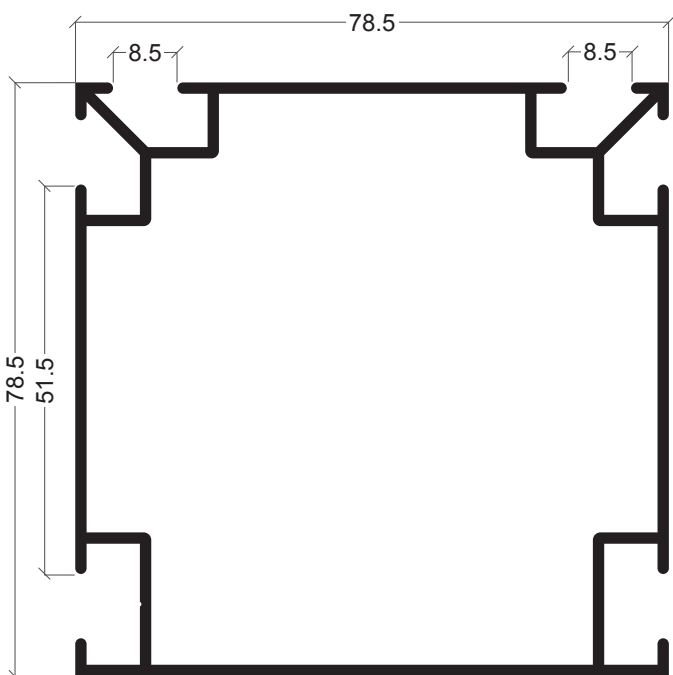

TR-17

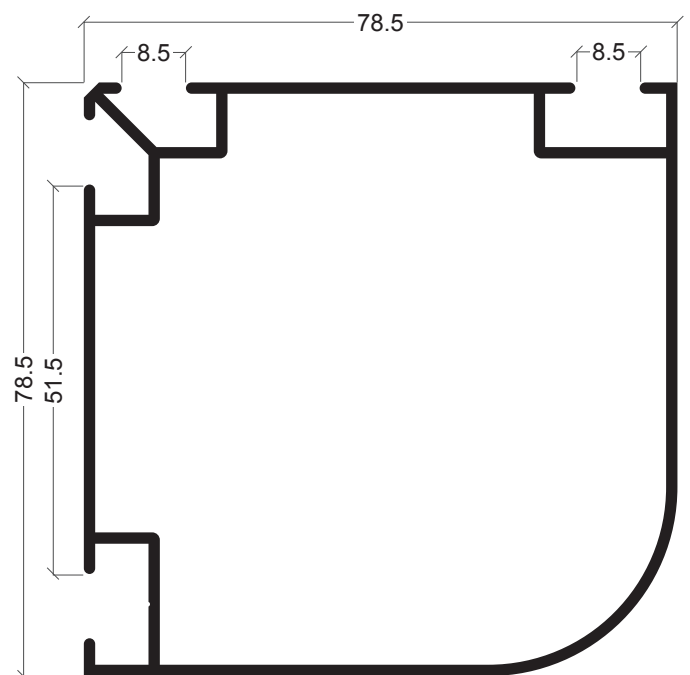

TR-18



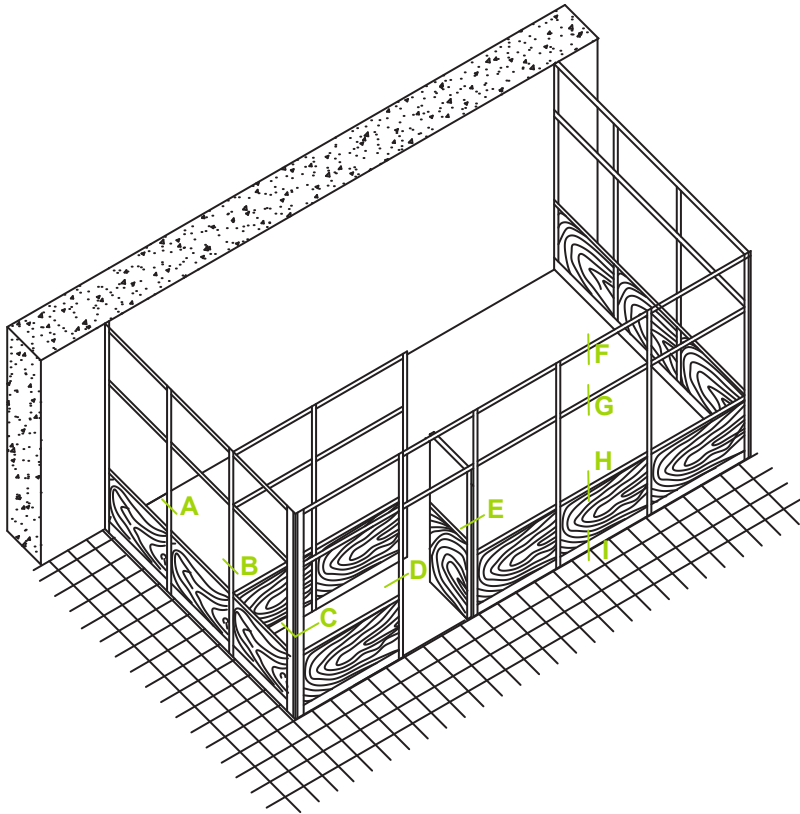

Pormenor de fixação

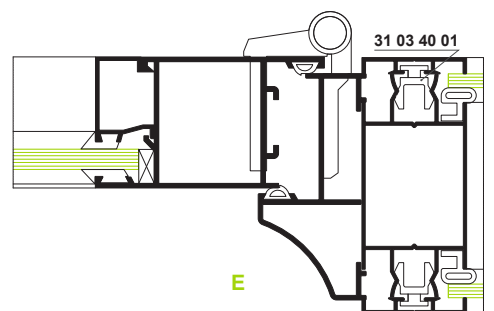
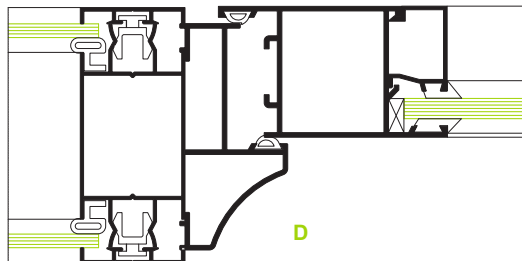
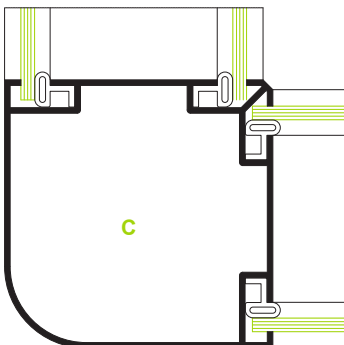
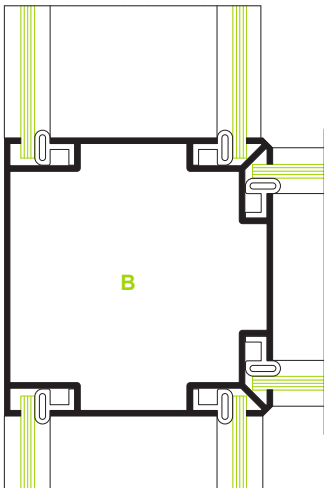
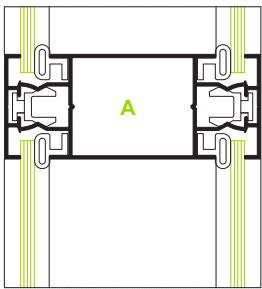
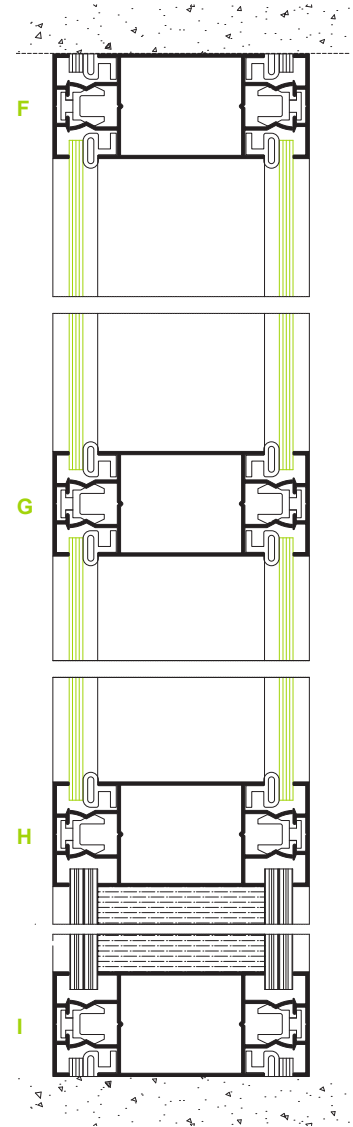
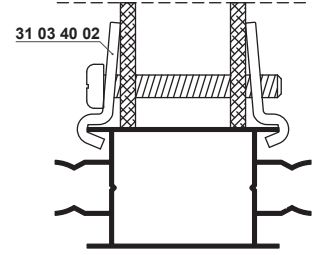

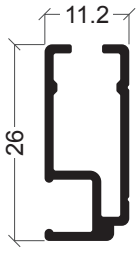

MA-11

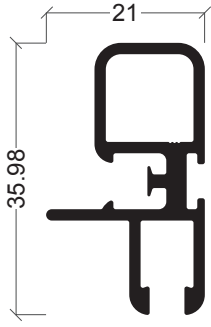

MA-01

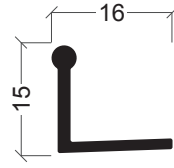

MA-02

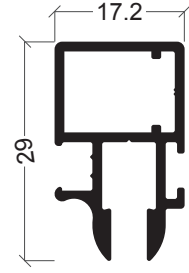

MA-03

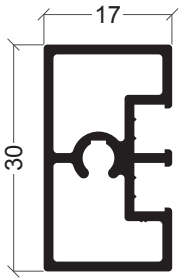

MA-04



MA-05



MA-06

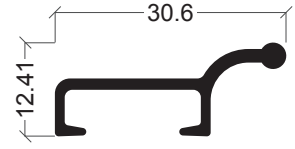

MA-07



MA-08



MA-09

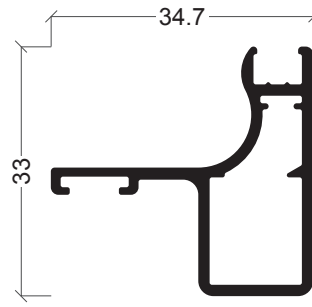

MA-10

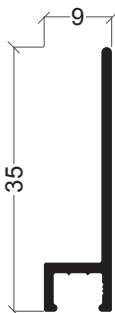

Z-50

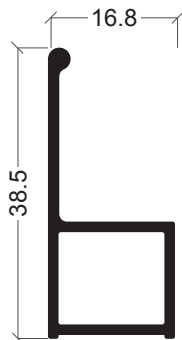

MA-13

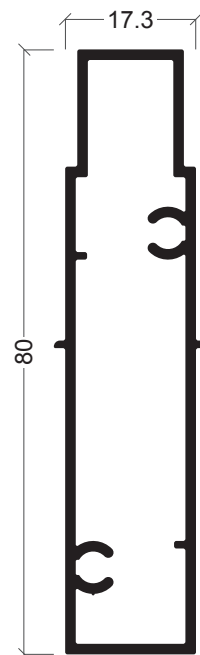

MA-12



P-34



B-24

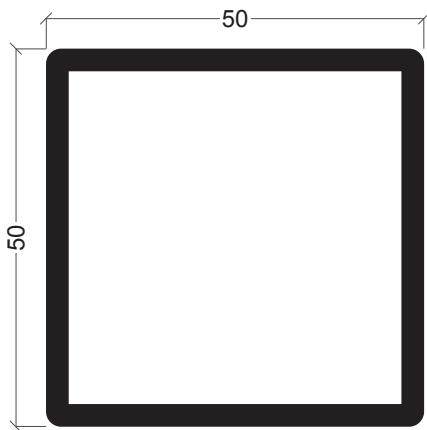

Q-28

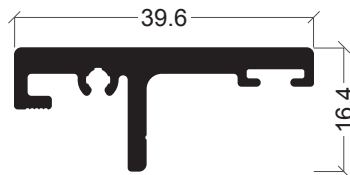

PO-10

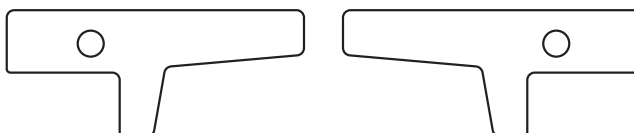

31 01 50 13  
Conjunto topo PO-10

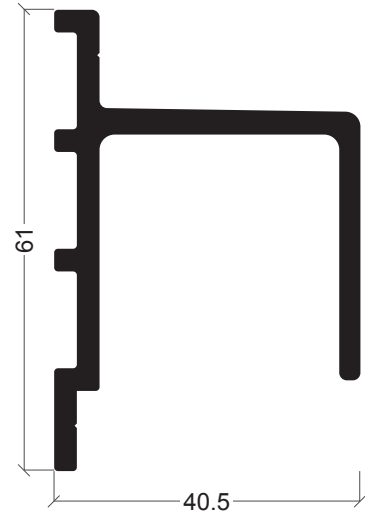

PO-09

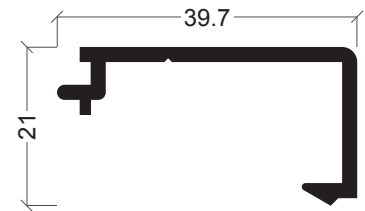

PO-05

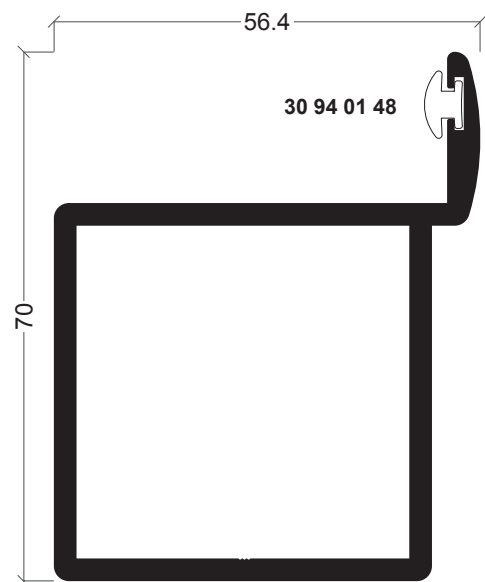

PO-01



30 94 01 48  
Junta para portão

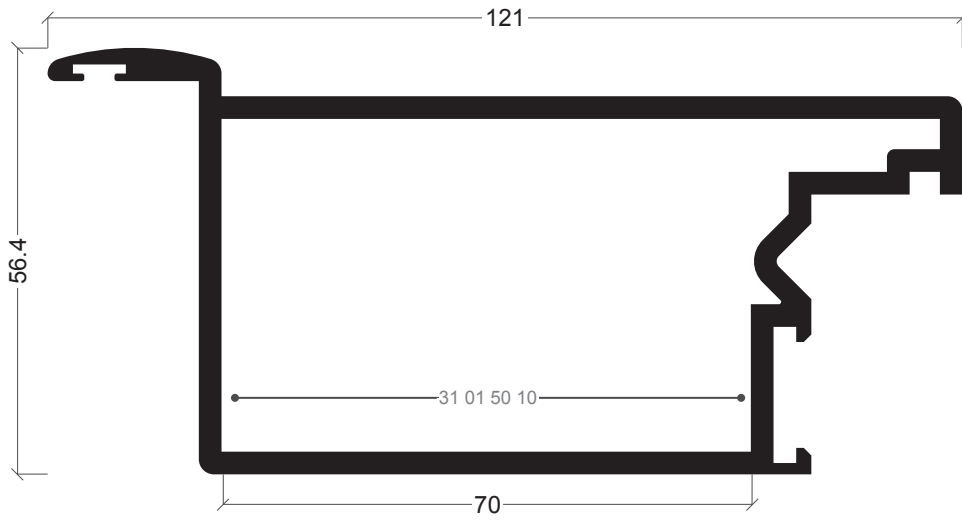

**PO-02**

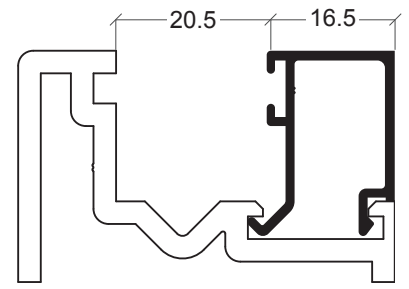

**AX-46**

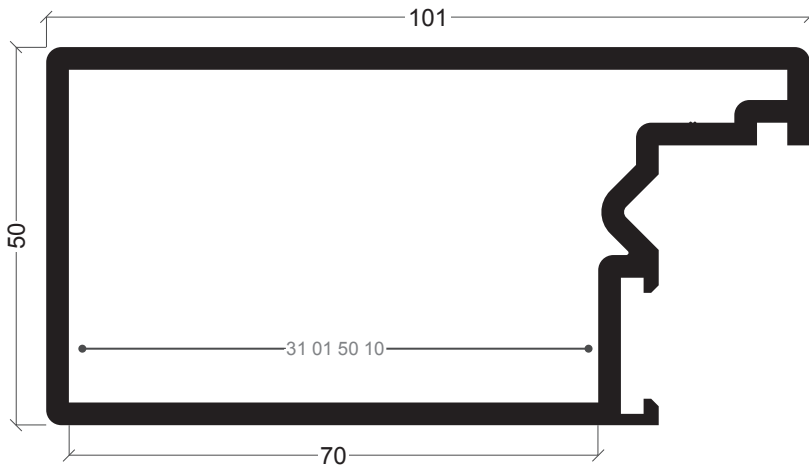

**PO-03**

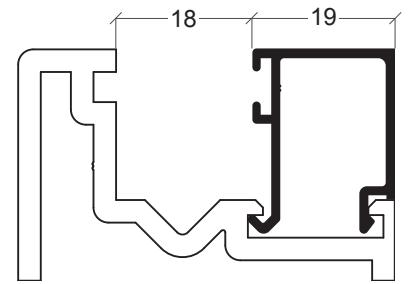

**AX-35**

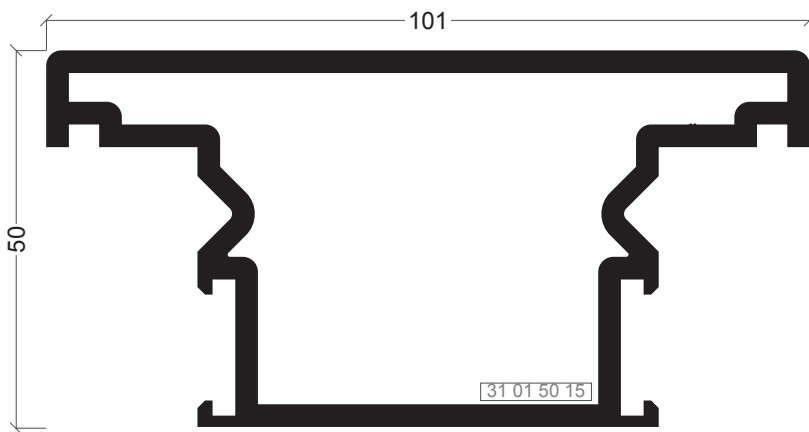

**PO-06**

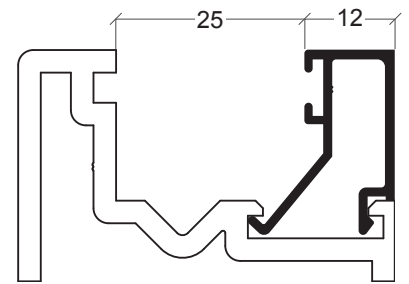

**AX-36**

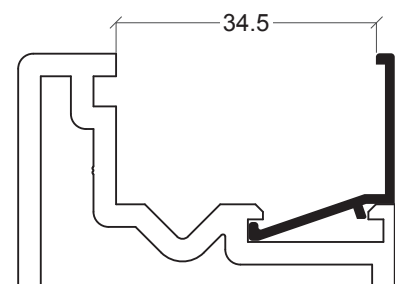

**AX-69**

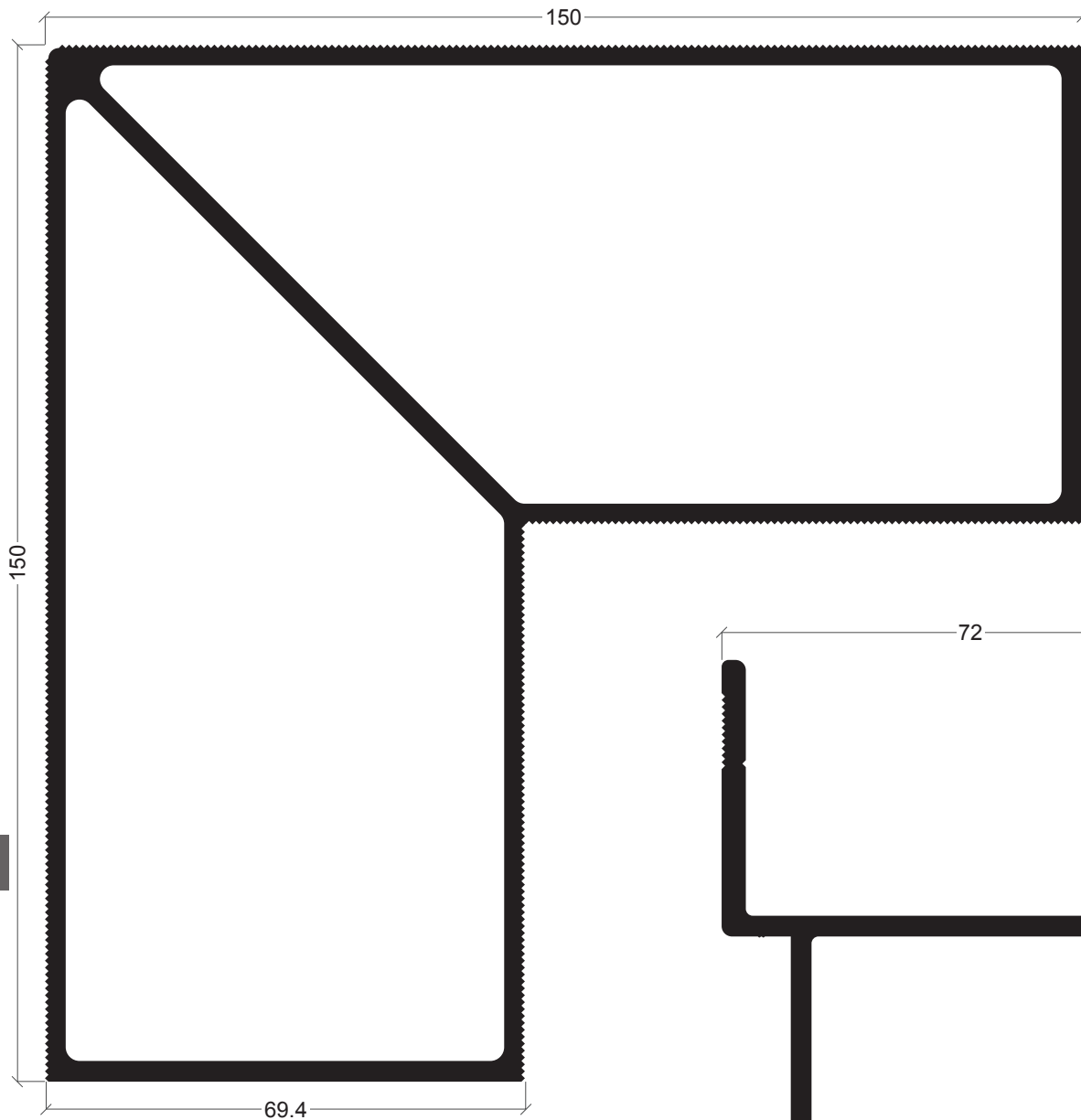

PO-08

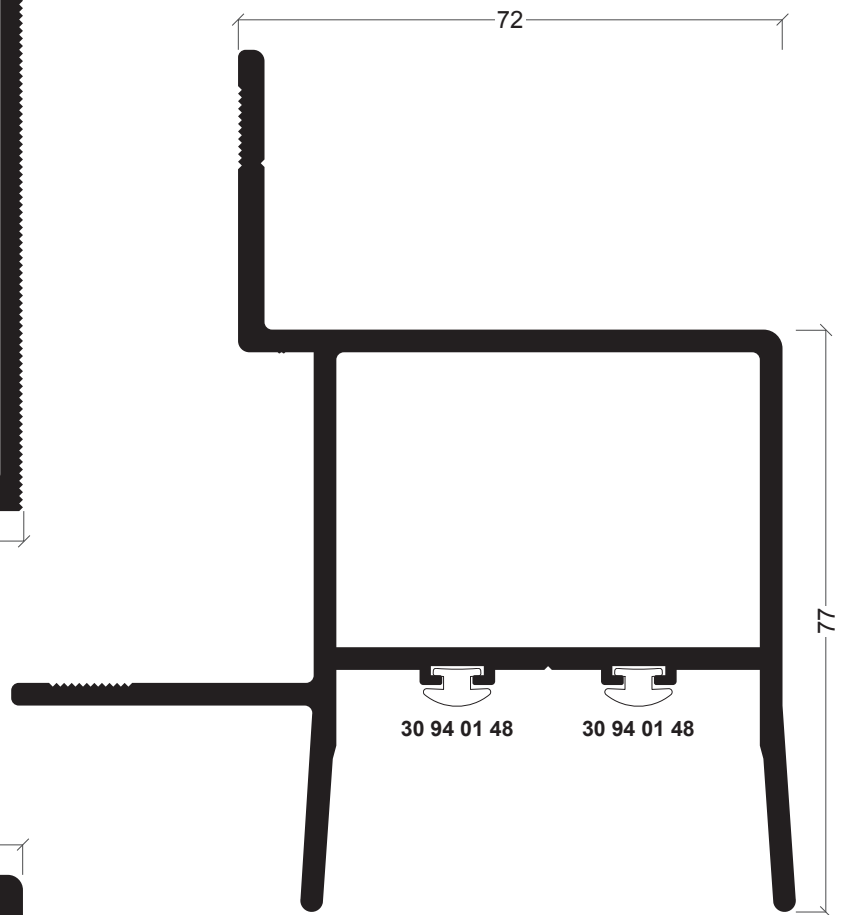

PO-04

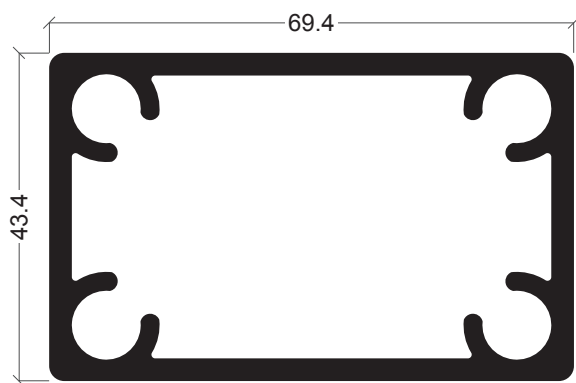

PO-07

Portão 2 folhas de abrir - lâminas fixas

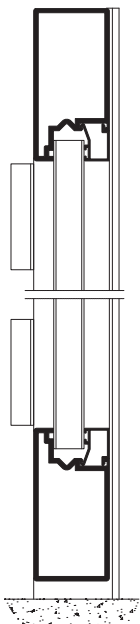

Secção A-A

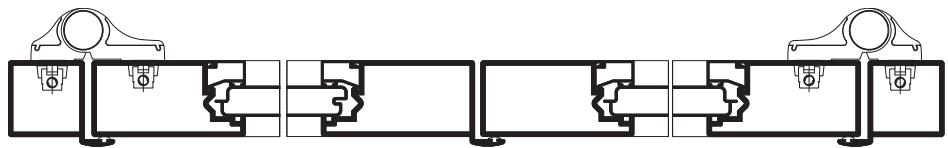

Secção B-B

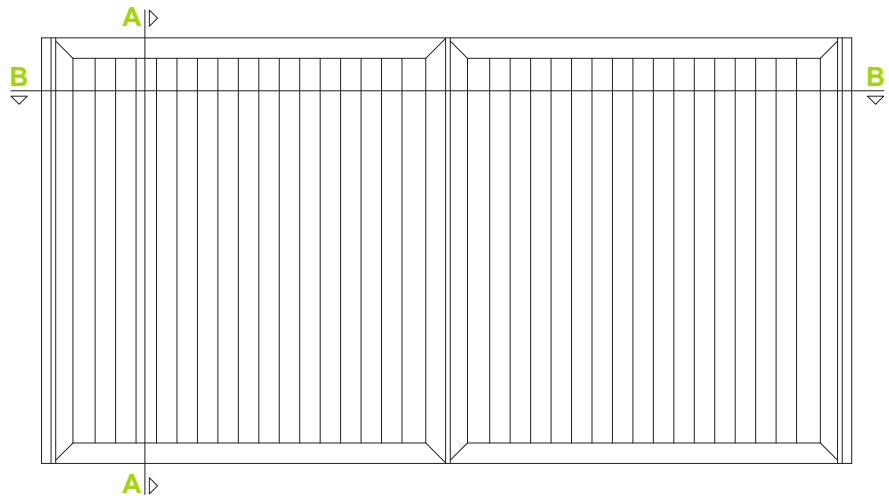

Portão de correr - balaustres + lâminas fixas

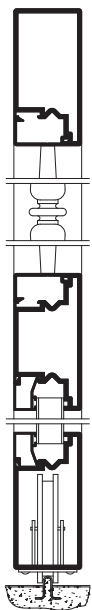

Secção A-A

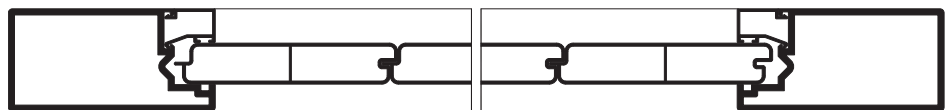

Secção C-C

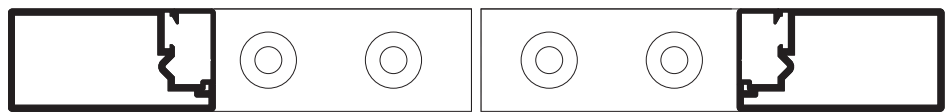

Secção B-B

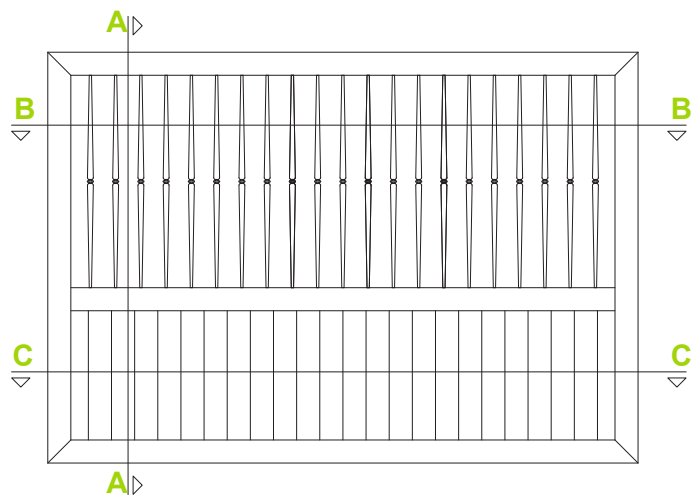
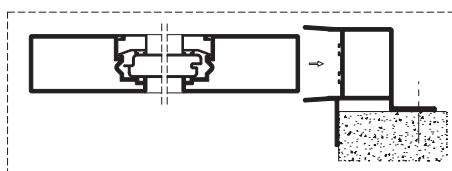

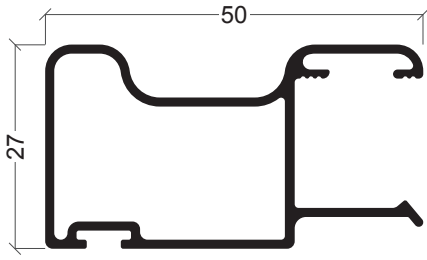

RD-01

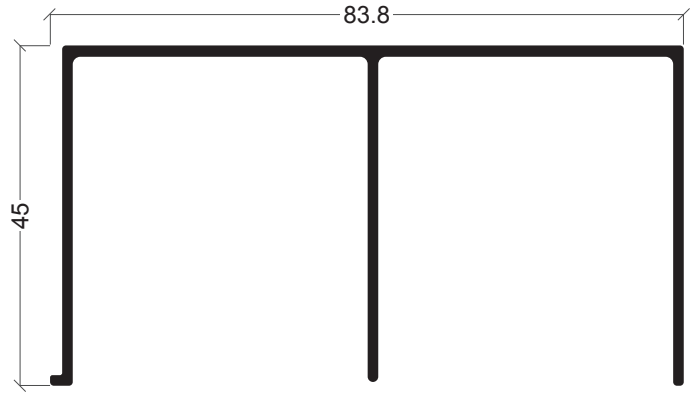

RD-04

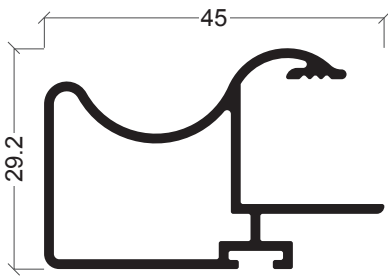

RD-07

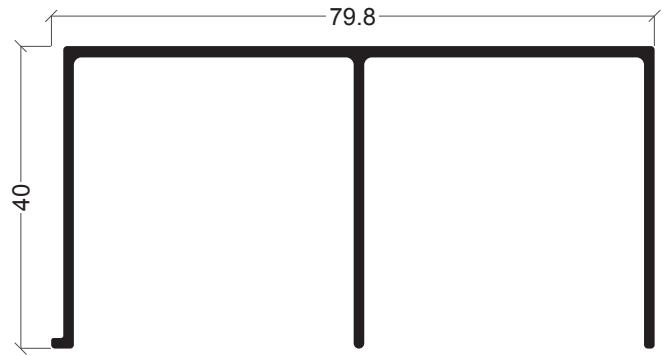

RD-05

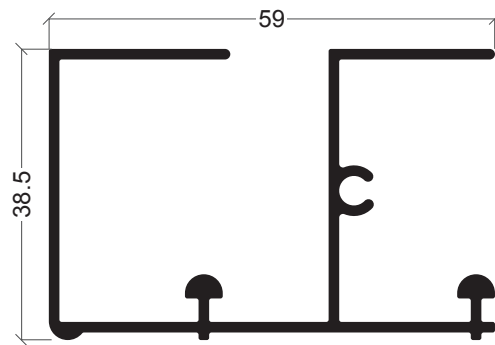

RD-02

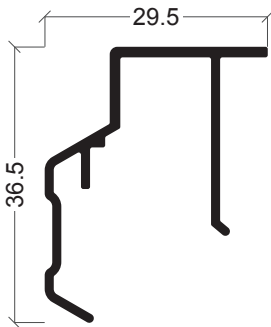

RD-03

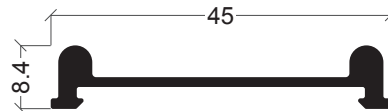

RD-06

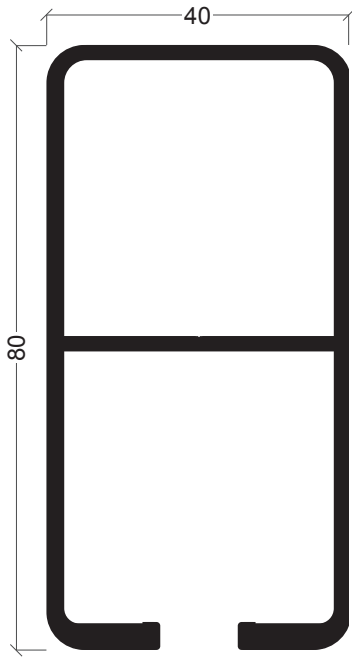

H-07

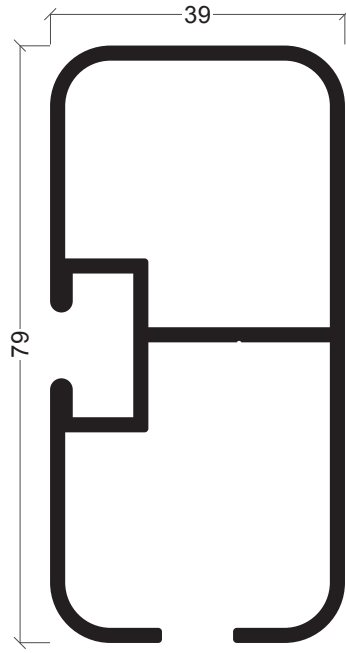

H-08

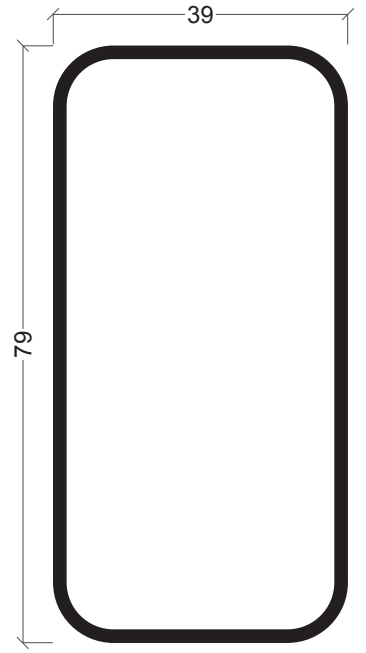

H-10

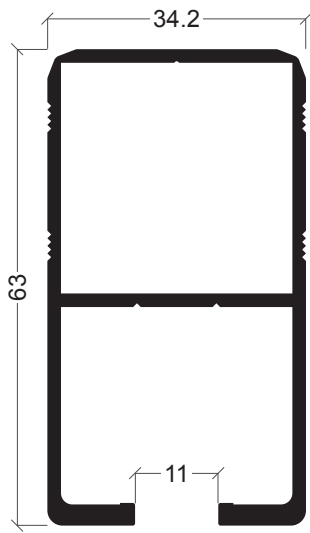

H-03

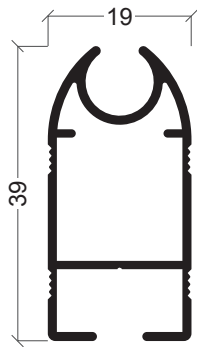

H-01

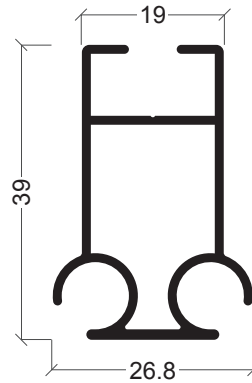

H-04

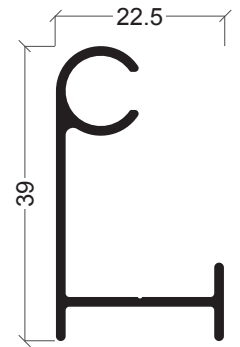

H-09

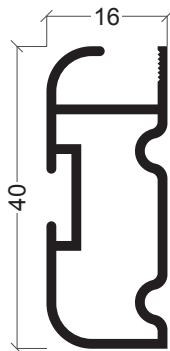

H-20

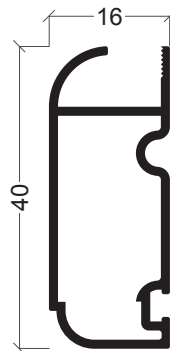

H-21

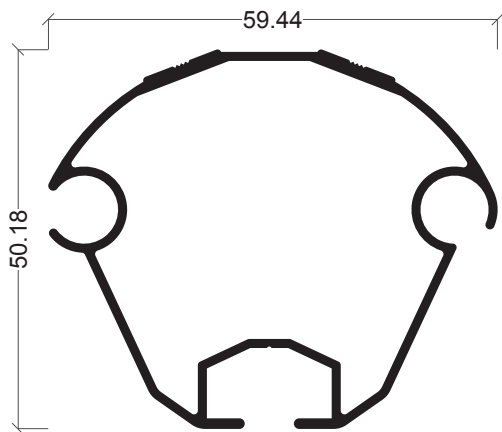

H-06

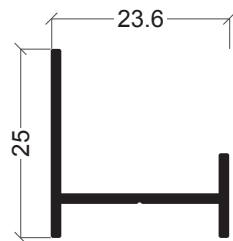

H-02

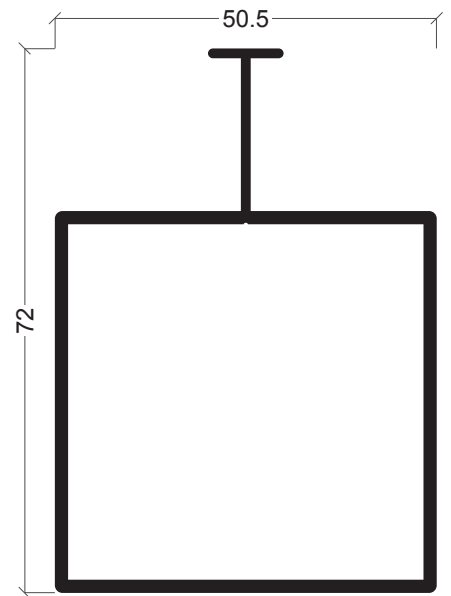

H-05





S-05

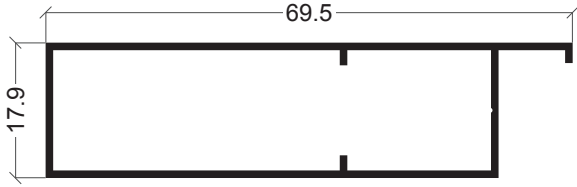

S-04

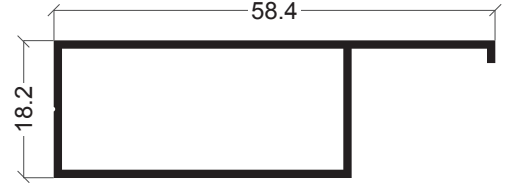

S-03

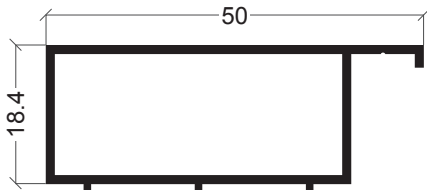

S-02

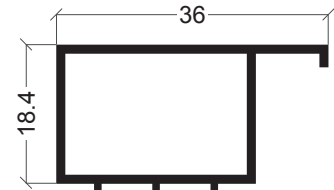

S-01

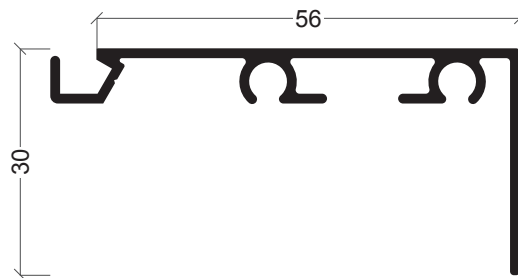

S-07

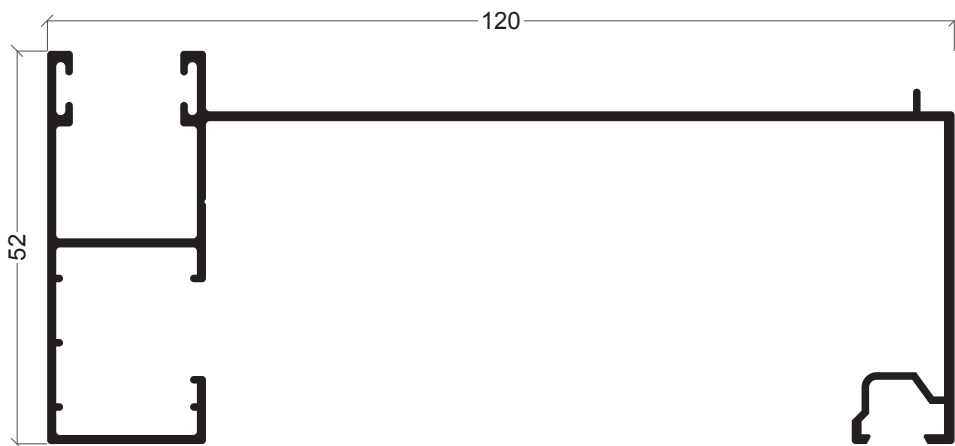

Y-30



S-09

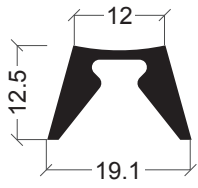

Y-03

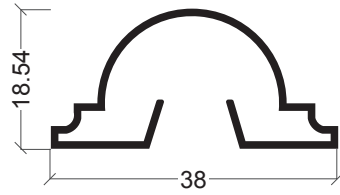

Y-16

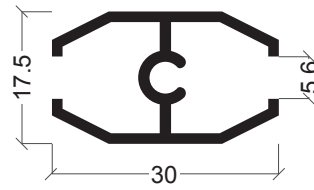

Y-07

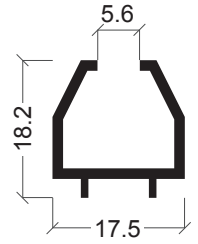

Y-06

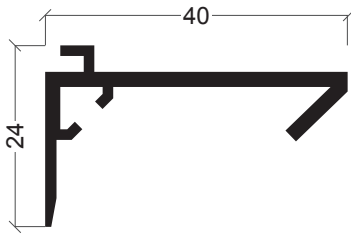

Y-23

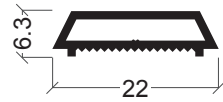

Y-12

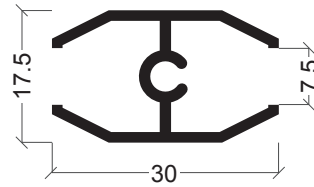

Y-19

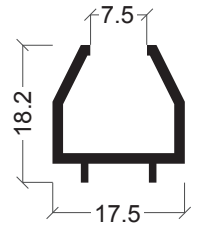

Y-18

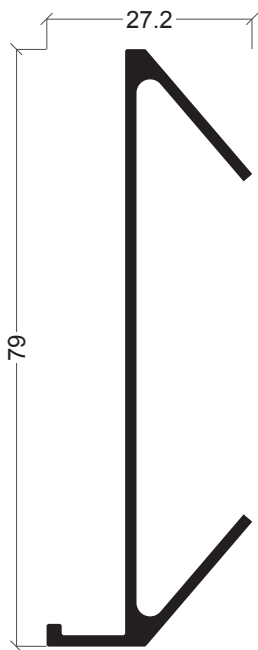

Y-15

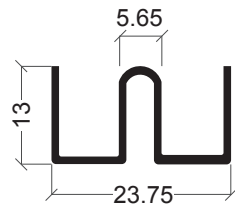

VM-01

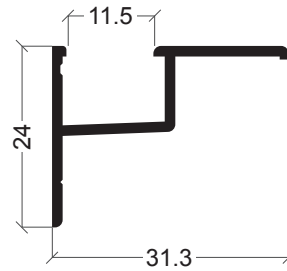

Y-20

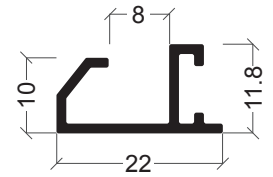

Y-10



VU-03



VH-02

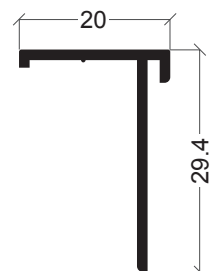

Y-24

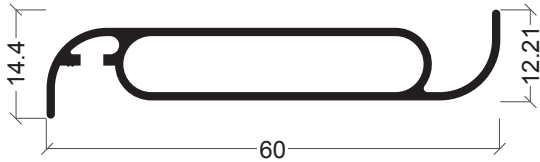

**Z-52**

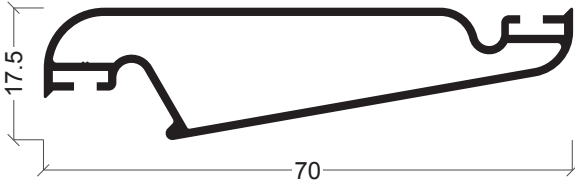

**Z-53**

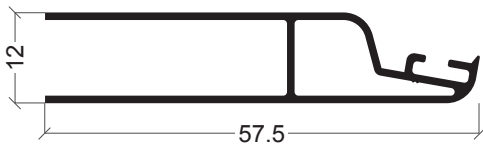

**Z-54**

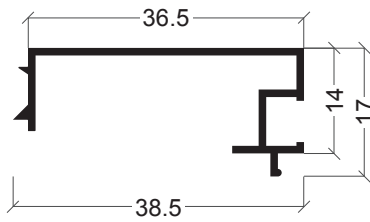

**Z-36**

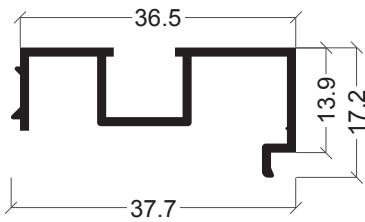

**Z-46**

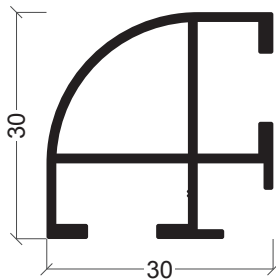

**PD-04**

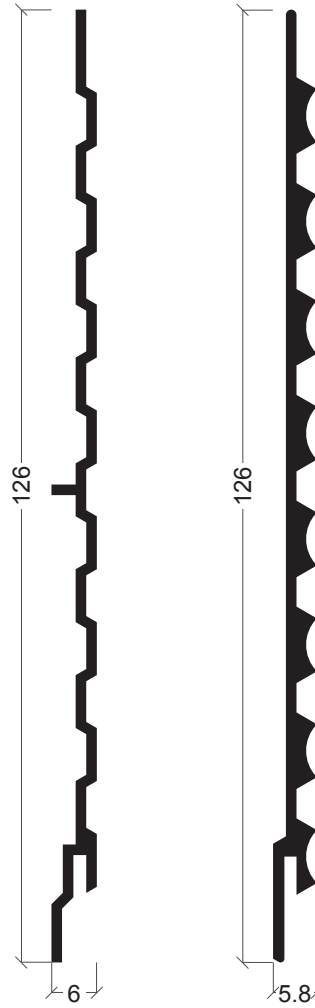

**W-01**

**W-19**

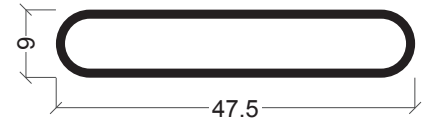

**Z-35**

**31 15 00 37**  
Conjunto suporte Z-35 preto

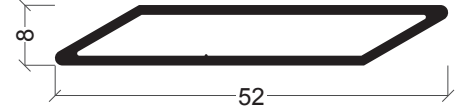

**Z-40**

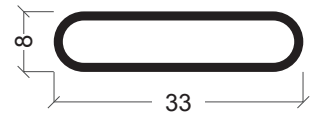

**Z-47**

**31 15 00 39**  
Conjunto suporte Z-47 preto

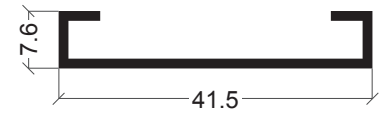

**Z-08**

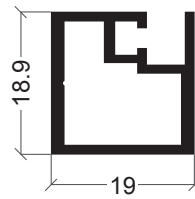

**PD-02**

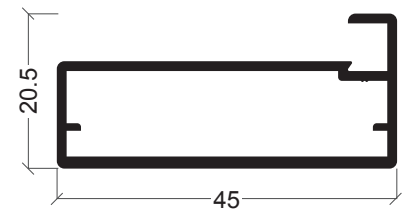

**PD-01**

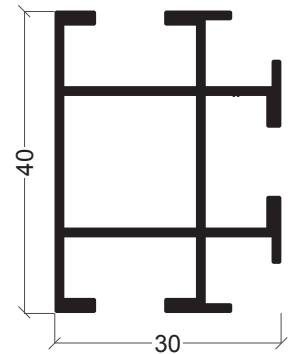

**PD-05**



Z-55

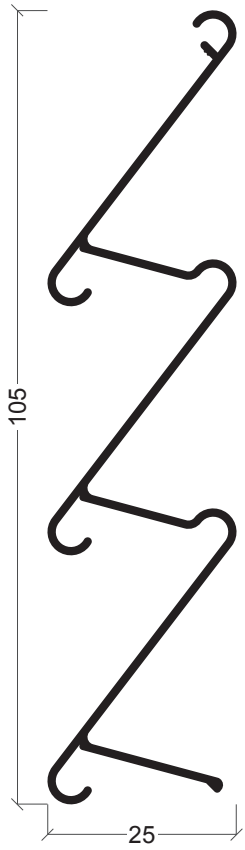

Z-20

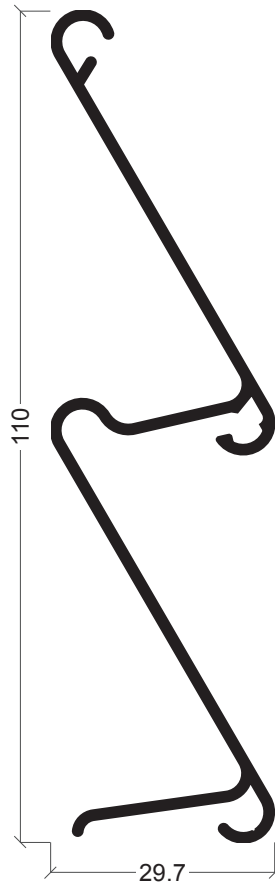

Z-34

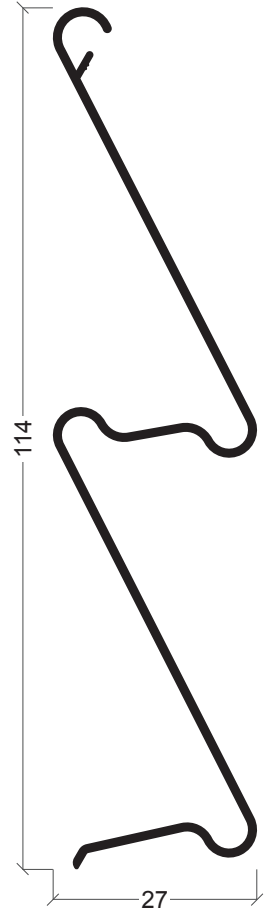

Z-28

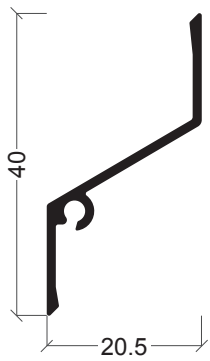

Z-26

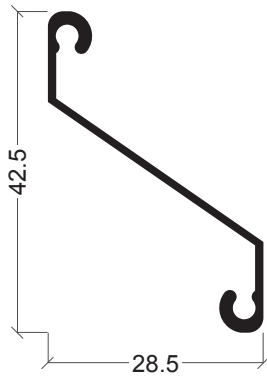

Z-04

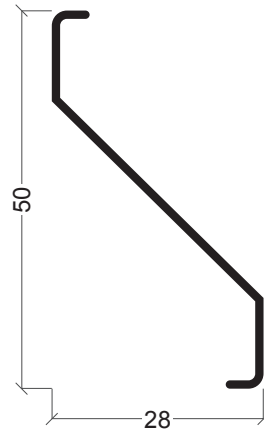

Z-37

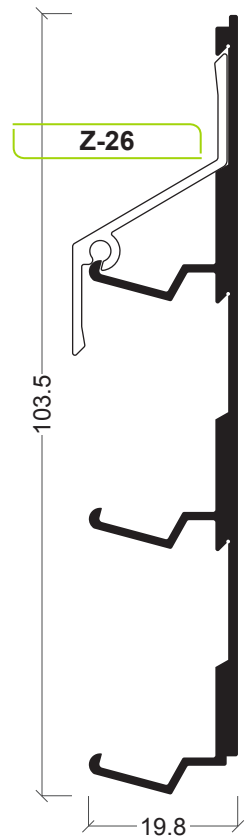

Z-25



M-03

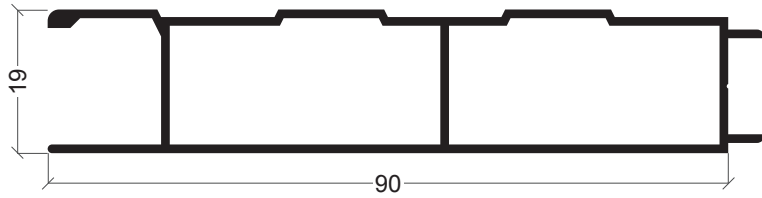

W-21

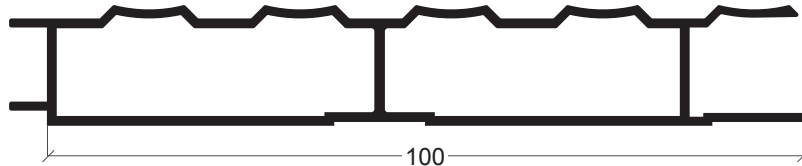

W-22

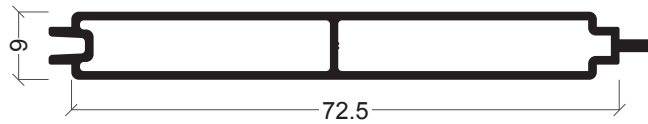

W-23

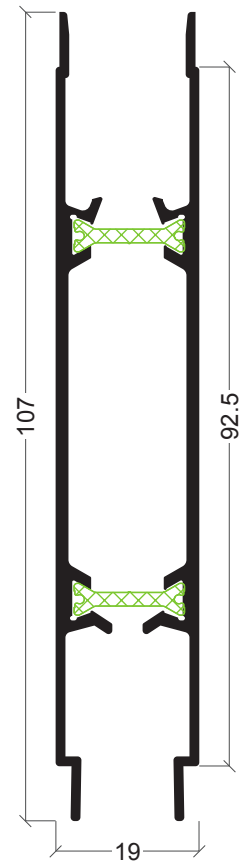

W-15

20

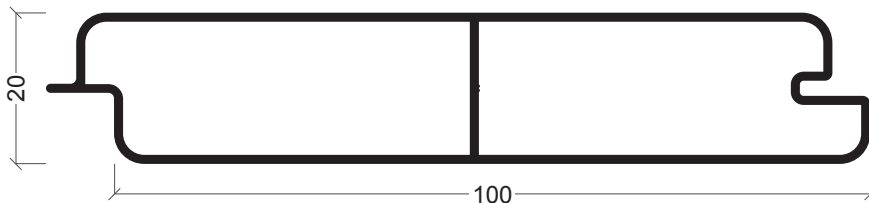

W-25



W-26

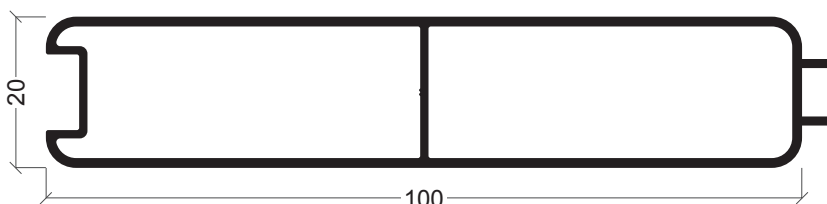

W-27

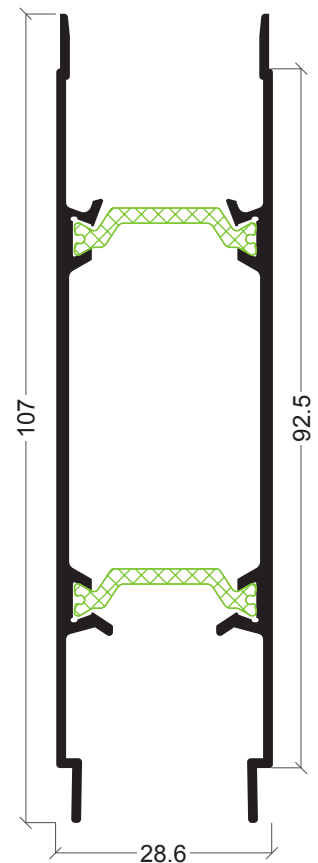

W-20

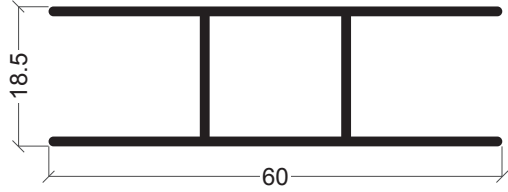

Z-15

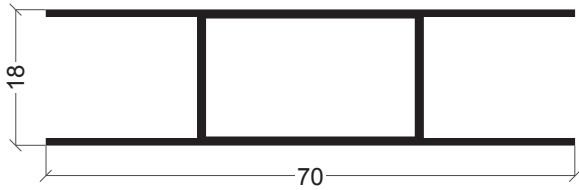

Z-07

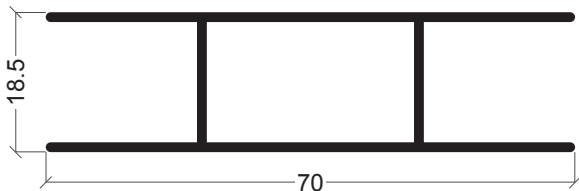

Z-16

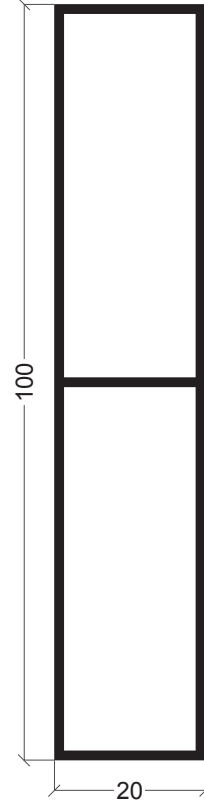

P-14

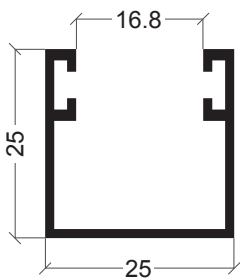

Z-09

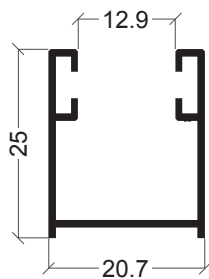

Z-30

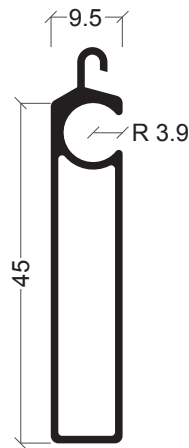

Z-49

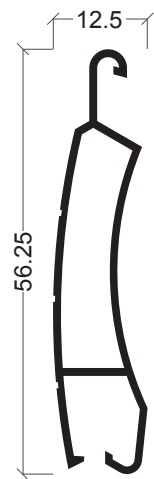

Z-44

**Cantoneiras**

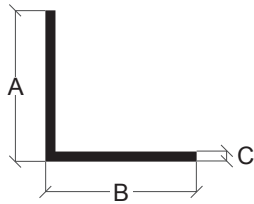

Referência	A	B	C
L-01	15	15	1.2
L-13	15	15	1.5
L-02	20	20	1.2
L-15	20	20	1.5
L-03	25	25	1.2
L-04	25	25	1.5
L-22	30	20	1.5
L-06	30	30	1.2
L-07	30	30	1.5
L-08	32	17	1.8
L-18	40	20	1.2
L-05	40	20	1.5
L-10	40	40	1.2
L-11	40	40	1.5
L-09	50	20	1.3
L-23	50	20	1.8
L-12	50	50	1.3
L-20	50	50	2
L-25	60	60	6

**Barras rectangulares**



Referência	A	B
B-07	20	2
B-04	20	3
B-05	20	4
B-14	20	5
B-18	20	10
B-08	25	2
B-06	25	3
B-11	25	4
B-12	25	5
B-01	30	2
B-09	30	3
B-13	30	4
B-15	30	5
B-16	40	2
B-17	40	3
B-10	40	4
B-22	40	5
B-02	45	3
B-03	50	2
B-19	50	3
B-20	50	4
B-21	50	5
B-24	50	8
B-26	52	20

**Calhas U**

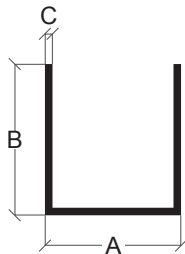

Referência	A	B	C
U-02	18	18	1
U-03	18	20	1
U-05	20	20	1.1
U-07	20	40	1.8
U-08	14	45	3

**Redondos**

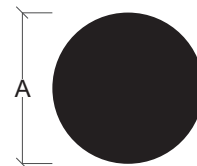

Referência	A
G-03	6
G-01	8
G-04	10

**Tubos redondos**

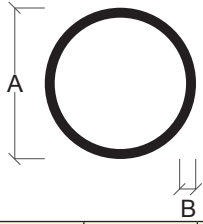

Referência	A	B
R-02	6	1
R-05	8	1
R-01	9	1.4
R-06	10	1
R-03	16	1
R-12	18	1.2
R-04	19	1.2
R-16	20	1.3
R-13	22	1.5
R-07	23	1.5
R-17	25	1.5
R-18	30	1.2
R-08	30	1.5
R-21	40	1.3
R-09	40	1.7
R-19	45	1.2
R-22	45	1.7
R-23	50	1.3
R-10	50	1.7
R-24	60	1.3
R-11	60	1.9
R-25	70	1.5
R-26	80	1.5
R-27	90	2
R-28	100	2

**Quadrados**



Referência	A
F-03	15
F-05	20
F-04	25

**Perfis em tê**

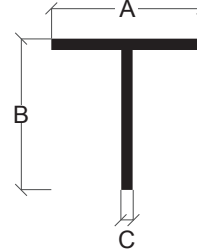

Referência	A	B	C
T-01	20	20	1.5
T-02	25	25	1.5
T-03	25	25	2
T-06	30	30	1.4
T-04	30	30	2
T-07	40	40	1.3
T-05	40	40	2

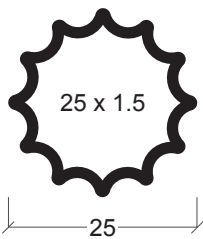

**R-14**

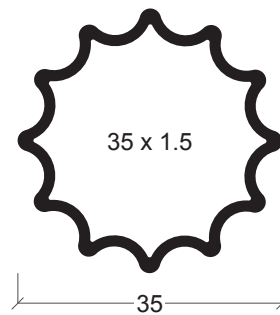

**R-15**

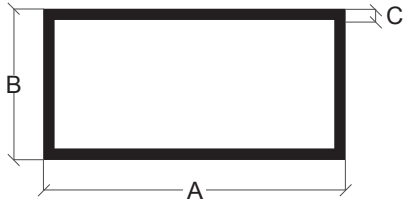

**Tubos retangulares**

Referência	A	B	C
P-01	30	12.5	1.5
P-27	30	15	1.2
P-02	30	15	1.5
P-11	30	20	1.3
P-04	40	20	1.3
P-03	40	20	2
P-19	50	25	1.3
P-06	50	30	1.5
P-07	50	34	2
P-18	60	15	1.3
P-08	60	20	1.3
P-05	60	40	1.2
P-20	60	40	1.5
P-09	65	30	1.5
P-12	70	20	1.3
P-22	70	40	1.5
P-10	75	40	1.5
P-26	80	20	1.2
P-21	80	20	1.5
P-23	80	30	1.5
P-29	80	40	1.3
P-24	80	40	2
P-13	85	30	1.8
P-25	100	18	2
P-32	100	40	1.4
P-28	100	40	2
P-33	100	45	1.4
P-15	100	45	2
P-31	100	60	2
P-30	120	40	1.7
P-17	150	25	2

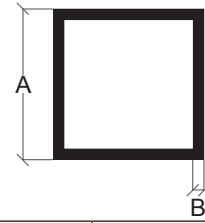
**Tubos quadrados**

Referência	A	B
Q-10	16	1
Q-01	19	1
Q-18	20	1.3
Q-02	20	2
Q-25	25	1.2
Q-03	25	1.5
Q-22	30	1.2
Q-04	30	1.5
Q-24	35	1.2
Q-05	35	1.5
Q-12	40	1.2
Q-06	40	1.5
Q-15	45	1.3
Q-07	50	1.5
Q-26	50	2
Q-14	60	1.3
Q-20	60	2
Q-09	65	1.5
Q-16	70	1.3
Q-08	70	2
Q-27	75	1.5
Q-11	75	2
Q-17	80	1.5
Q-21	80	2
Q-13	85	2
Q-19	100	1.4
Q-23	100	2

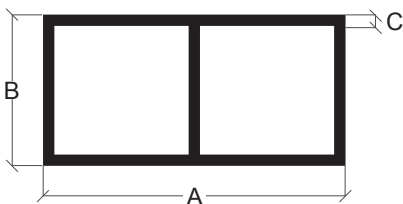
**Tubos retangulares  
parede ao centro**

Referência	A	B	C
P-14	100	20	1.3
P-16	125	15	1.8

**Tubos retangulares  
cantos arredondados**

Referência	A	B	C
P-34	80	50	3

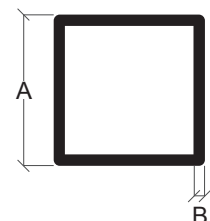
**Tubos quadrados  
cantos arredondados**

Referência	A	B
Q-28	50	3