

www.dineru.com



GP

Sistema de Portões e Gradeamentos

Sistema GP

Sistema de portões e gradeamento

Características do sistema

Sistema de alumínio para executar portões de batente ou de correr para entrada de habitações, possibilitando a execução de gradeamentos com a mesma aparência.

Produto executado de acordo com a norma europeia de Regulamentação geral EN 13241-1 de desempenho e de segurança.

O sistema GP alia os conceitos de qualidade, durabilidade e elegância, possuindo igualmente uma gama de acessórios de fácil aplicação e reduzida manutenção.

Os modelos de portão são compatíveis com os automatismos clássicos para abertura de batente ou de correr.

Perfis de alumínio

Os perfis de alumínio são extrudidos na liga de alumínio 6060 para a arquitetura de acordo com a norma NP EN 12020-02.

Os perfis de alumínio que compõe o sistema GP são lacados mediante o selo de qualidade Qualicoat, incluindo a classe Seaside (equivalente Qualmarine), ou anodizados cumprindo os requisitos do selo de qualidade Qualanod.

Portão de batente

Secção dos principais perfis de 50 mm com uma espessura média de 2.5 mm.

Possibilidade de execução de portão de 1 ou 2 folhas de abertura interior ou exterior com opção de sistema anti-entalamento de dedos.

Existem diversas tipologias de enchimento, de 9 mm a 20 mm.

União dos Aros feita através de parafusos especiais de abertura de rosca direta com tratamento anti-corrosão.

A união é reforçada com calços em alumínio.

Pivot superior em alumínio injetado de eixo 20 mm em inox permitindo afinação milimétrica nos 3 eixos.

Pivot inferior em alumínio injetado de eixo 20 mm permitindo regulações laterais.

Conjunto pivot em Cupro-Alumínio de eixo 12 mm com multi-regulação.

Dobradiças em alumínio de 2 ou 3 abas com reforço interior permitindo afinação nos 3 eixos.

Portão de correr

Secção dos principais perfis de 50 mm com uma espessura média de 2.5 mm.

Possibilidade de execução de portão de correr com diversas tipologias de enchimento de 9 mm a 20 mm.

União dos aros feita através de parafusos especiais de abertura de rosca direta e com tratamento anti-corrosão.

A união é reforçada com calços em alumínio.

Calha com suporte de roletos auto-regulável na vertical.

Fechadura com gancho automático.

Rodas de alta resistência e desempenho.

Calha em aço de 3 ou 6 metros para deslizamento das rodas.

Gradeamento

Secção dos principais perfis de 50 mm com uma espessura média de 2.5 mm.

Idêntica tipologia de perfis utilizada na execução do gradeamento.

União de aros feita através de parafusos especiais de abertura de rosca direta e com tratamento anti-corrosão.

Perfis verticais auto-ajustáveis.

Dimensionamento e manobralidade

Dimensões máximas para portão de batente 1 folha*: 1600 mm (L) x 2200 mm (H)

Dimensões máximas para portão de batente 2 folhas*: 5500 mm (L) x 2000 mm (H)

Dimensões máximas para portão de correr*: 6000 mm (L) x 2200 mm (H)

Dimensões máximas entre prumos para gradeamento*: 6500 mm (L) x 2200 mm (H)

* Dimensionamento máximo variável dependendo da tipologia de enchimento e ferragens de abertura.

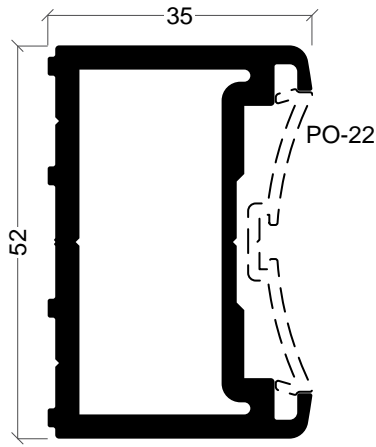

PO-11
Aro fixo

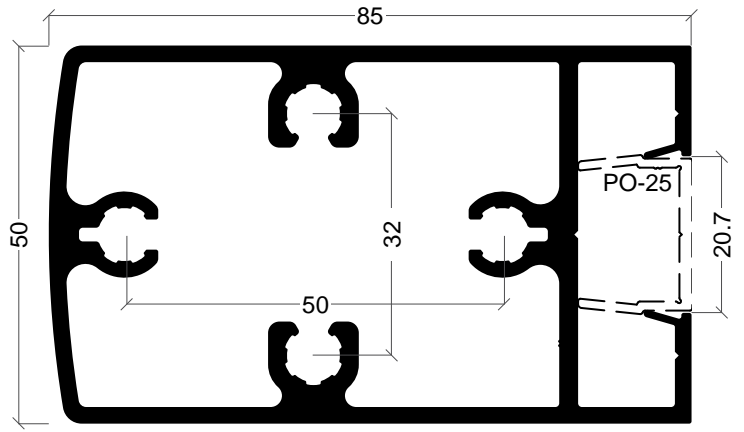

PO-12
Travessa

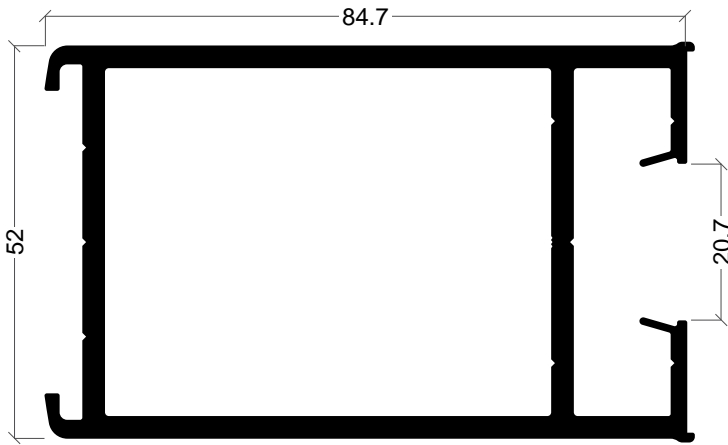

PO-13
Montante

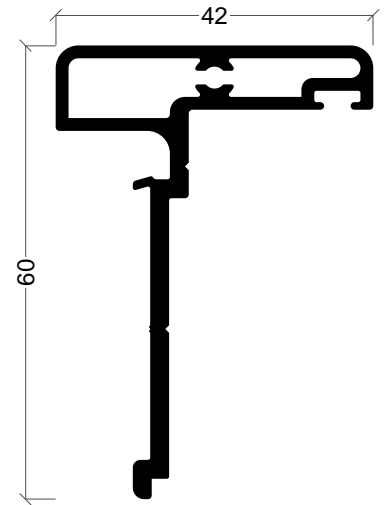

PO-20
Inversor

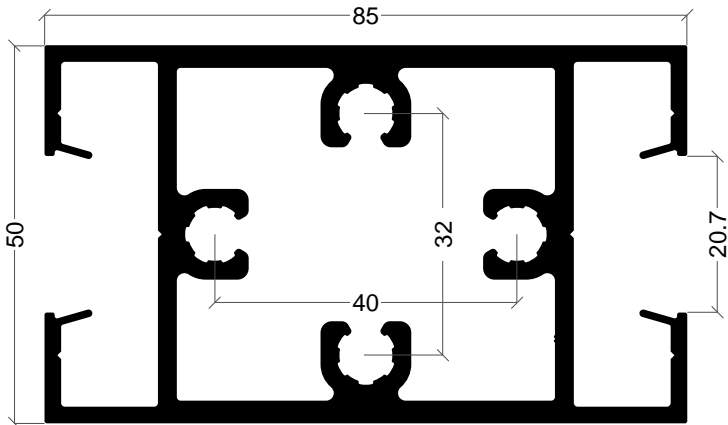

PO-16
Travessa intermédia

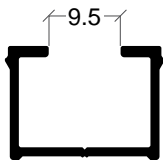

PO-15
Redutor

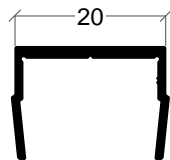

PO-25
Perfil tampa

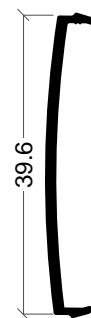

PO-14
Tampa

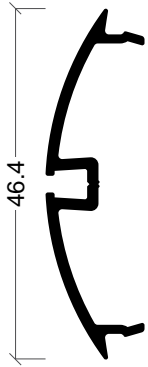

PO-21
Suplemento de batente



PO-22
Suplemento de batente

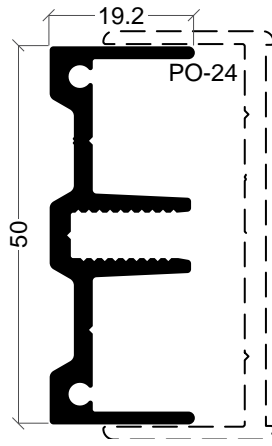

PO-23
Remate gradeamento

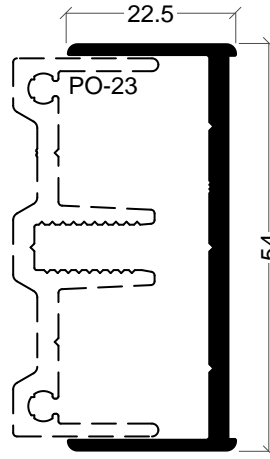

PO-24
Remate gradeamento

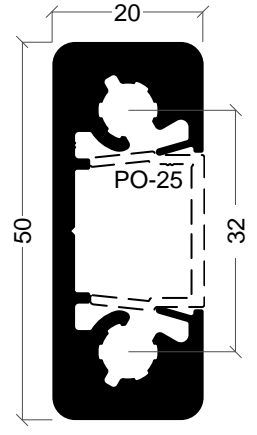

PO-26
Travessa gradeamento

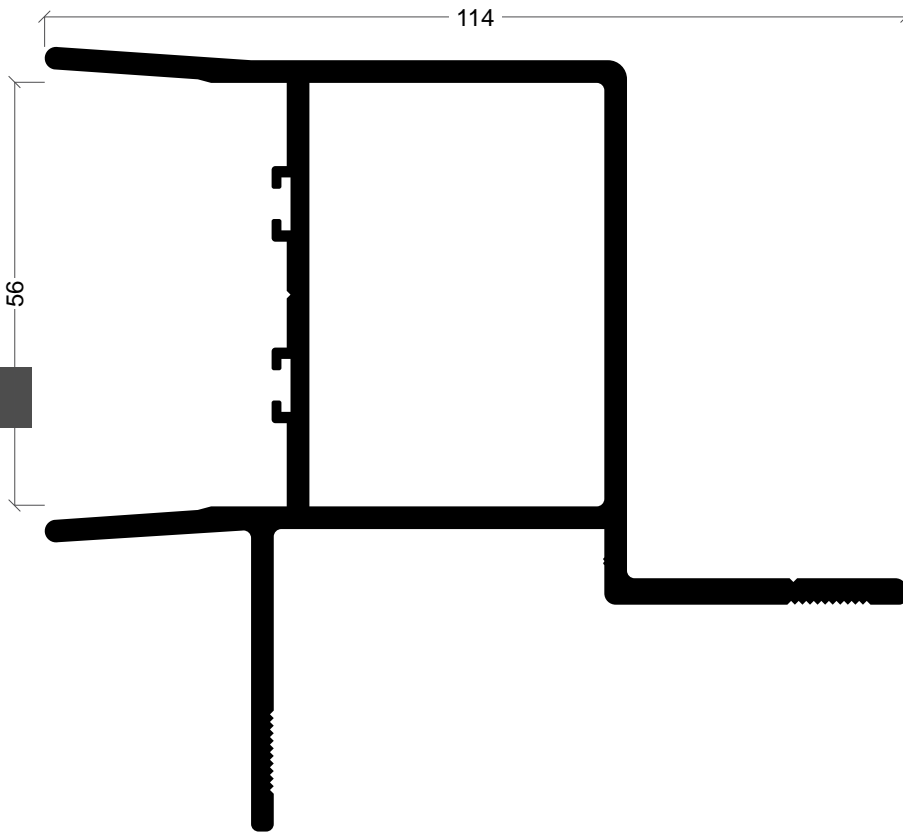

PO-04
Prumo fixo correr

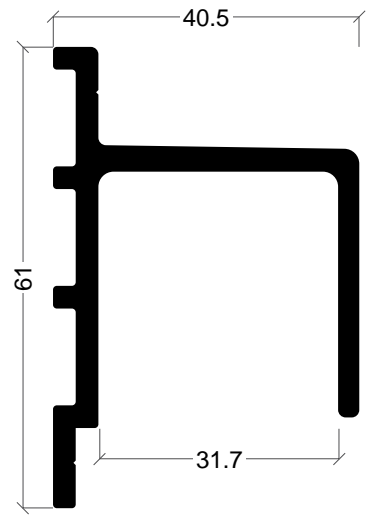

PO-09
Guia correr

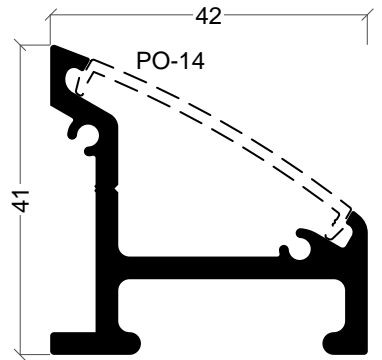

PO-19
Guia correr com tampa

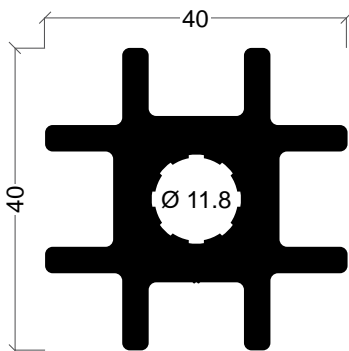

PO-17
Perfil de reforço

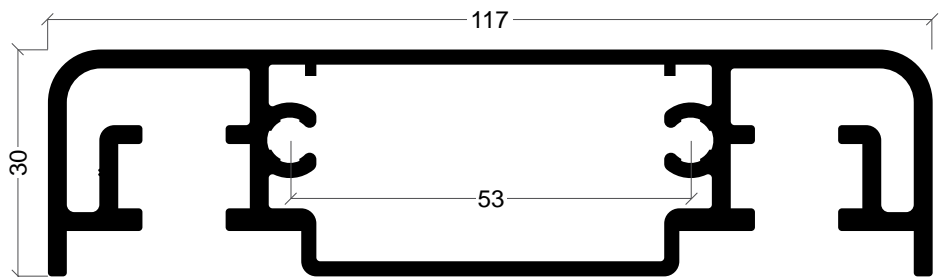

PO-18
Ponte para roletos

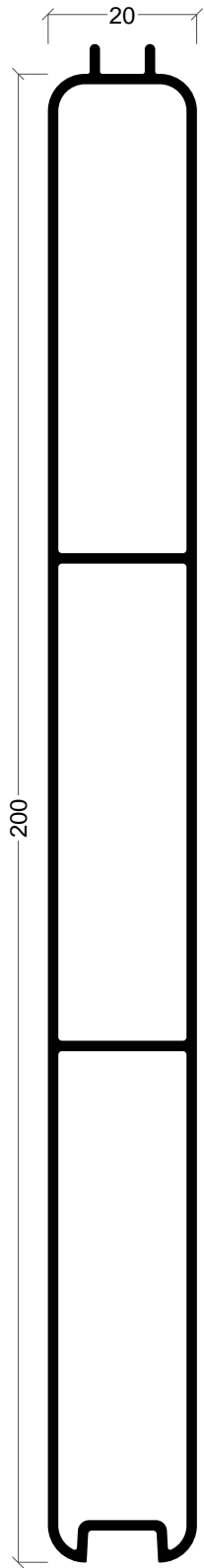

W-12
Lâmina 200 mm

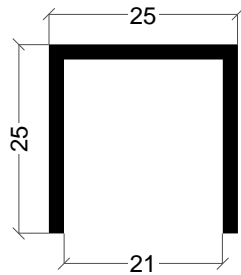

U-11
Perfil de remate

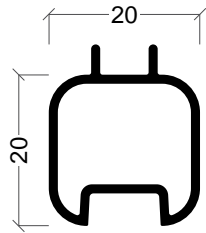

W-16
Lâmina 20 mm

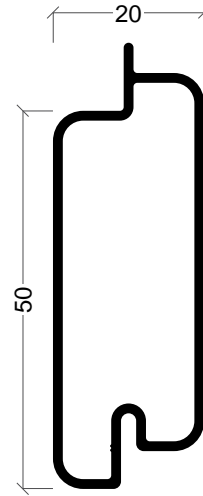

W-26
Lâmina 50 mm

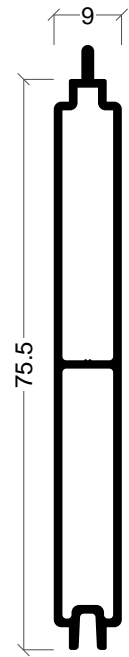

W-23
Lâmina 75.5 mm

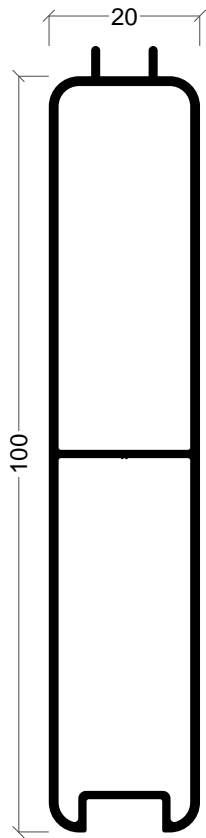

W-27
Lâmina 100 mm

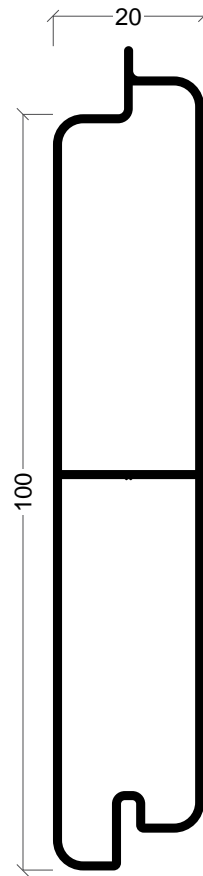

W-25
Lâmina 100 mm

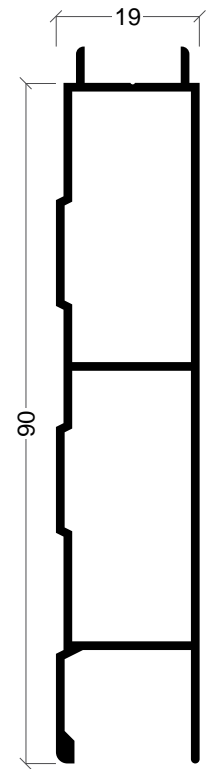

W-21
Lâmina 90 mm

Referência	A	B	Esp.
Q-02	20	-	2
P-11	30	20	1.3
P-04	40	20	1.2
Q-20	60	-	2
Q-09	65	-	1.5
P-21	80	20	1.5
P-14 *	100	20	1.3

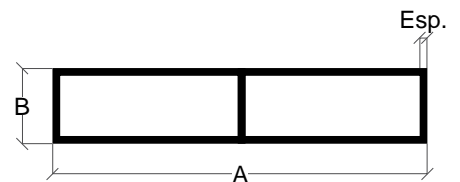
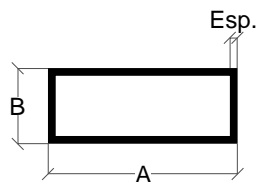
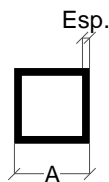

* Parede ao centro

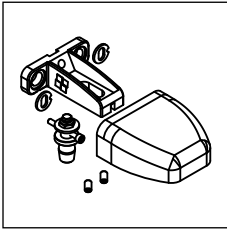

30 01 60 10/11
Pivot superior E20 mm
(branco/preto)

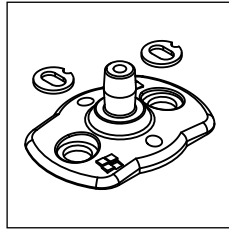

30 01 60 13/14
Pivot inferior E20 mm
(branco/preto)

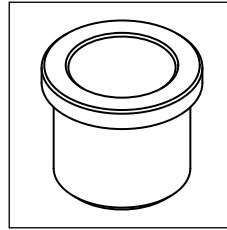

30 01 60 19
Casquilho nylon E20 mm
(branco)

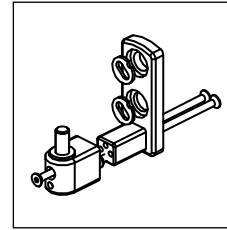

30 01 60 20/21
Conjunto pivot E12 mm
(branco/preto)

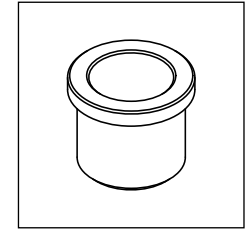

30 01 60 25
Casquilho nylon E12 mm
(branco)

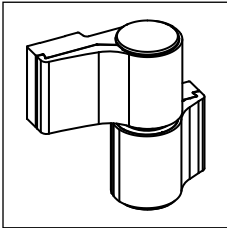

30 01 60 30/31
Dobradiça 2 abas 3D lisa
(branco/preto)

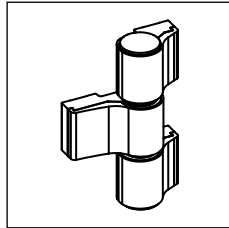

30 01 60 33/34
Dobradiça 3 abas 3D lisa
(branco/preto)

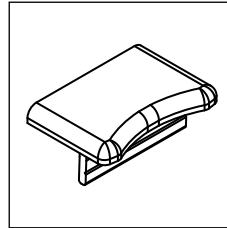

30 01 60 40/41
Topo PO-11 + PO-22
(branco/preto)

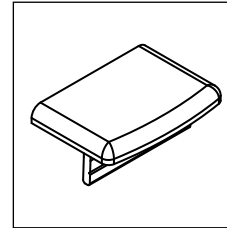

30 01 60 43/44
Topo PO-11 (branco/
preto)

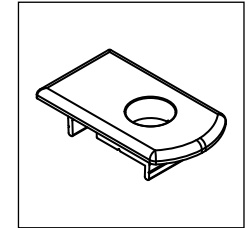

30 01 60 46/47
Topo PO-13 + PO-21
E20 mm (branco/preto)

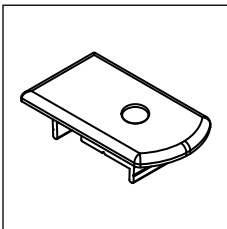

30 01 60 49/50
Topo PO-13 + PO-21
E12 mm (branco/preto)

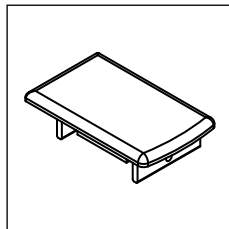

30 01 60 52/53
Topo PO-13 (branco/
preto)

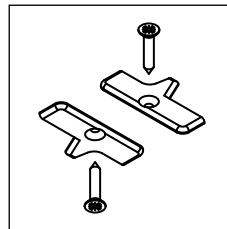

30 01 60 55/56
Jogo topos inversor
PO-20 (branco/preto)

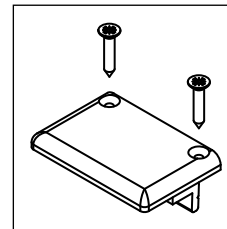

30 01 60 58/59
Topo fixo para gradeamento
(branco/preto)

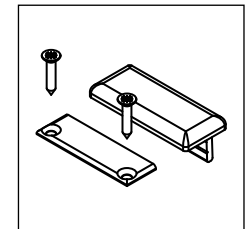

30 01 60 61/62
Jogo topos reg. para
gradeamento (branco/preto)

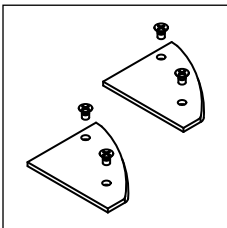

30 01 60 64/65
Jogo topos guia PO-19
(branco/preto)

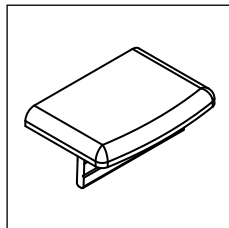

30 01 60 67/68
Topo prumo PO-04
(branco/preto)

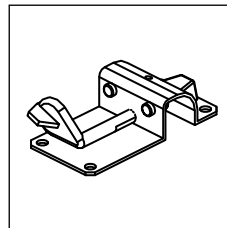

30 01 60 80
Batente central inox
abertura manual

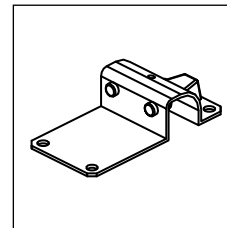

30 01 60 81
Batente central inox
abertura motorizada

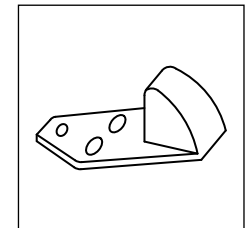

30 01 60 82/83
Batente central abertura
motorizada (branco/preto)

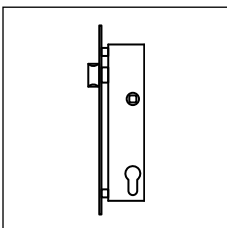

30 01 60 90
Fechadura prumo
batente 40 mm

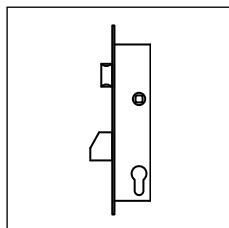

30 01 60 91
Fechadura prumo
batente 35 mm

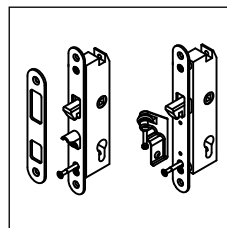

30 01 60 95/96
Fechaduras
semi-automáticas correr

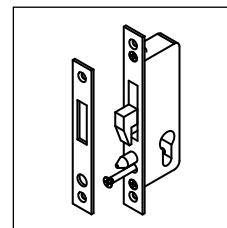

30 01 60 97
Fechadura manual correr

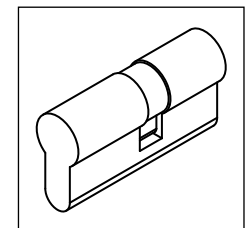

30 01 61 00
Canhão Euro cromado

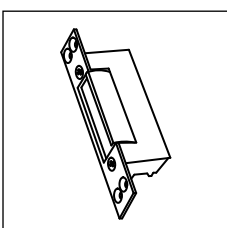

30 01 61 10
Testa elétrica

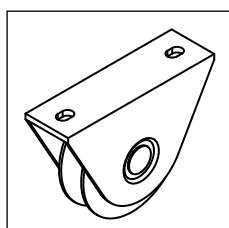

30 01 61 20
Roda com suporte
triangular

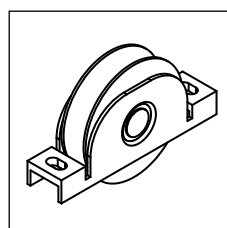

30 01 61 21
Roda com suporte
inferior

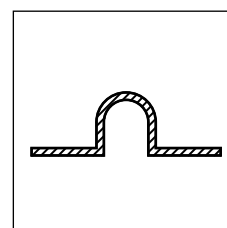

30 01 61 25/26
Calha de aço em U (3
mts / 6 mts)

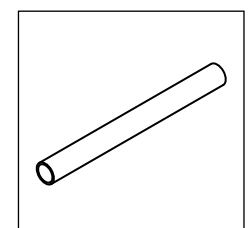

30 01 61 27
União para calha

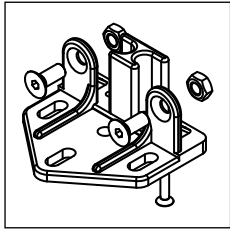

30 01 61 30/31
Fixador para ponte
PO-18 (branco/preto)

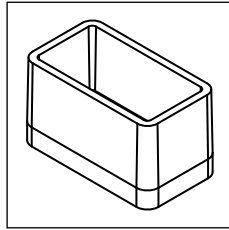

30 01 61 33
Fixador interior para
ponte PO-18

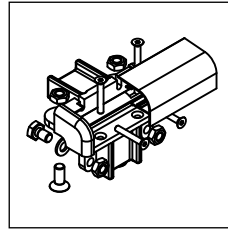

30 01 61 34/35
Ângulo para ponte PO-18
(branco/preto)

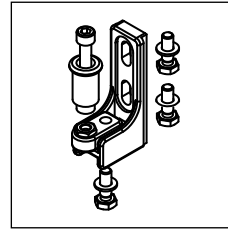

30 01 61 37/38
Suporte regulável para
rolete (branco/preto)

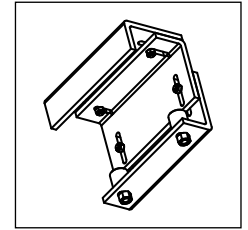

30 01 61 40/41
Ponte com roletos 30
mm (branco/preto)

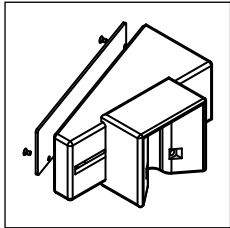

30 01 61 50/51
Conjunto de fecho correr
(branco/preto)

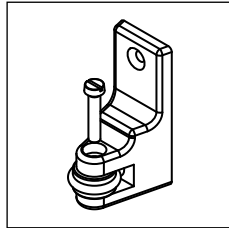

30 01 61 53/54
Engate para fecho correr
(branco/preto)

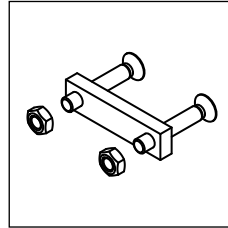

30 01 61 56
Gache fecho correr

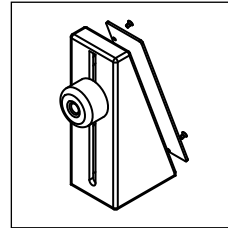

30 01 61 57/58
Batente correr (branco/
preto)

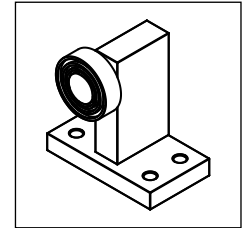

30 01 61 60/61
Batente correr alumínio
(branco/preto)

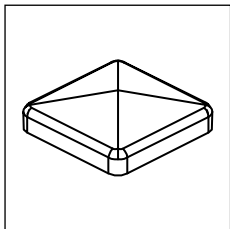

30 01 61 70/71
Topo piramidal 60x60
(branco/preto)

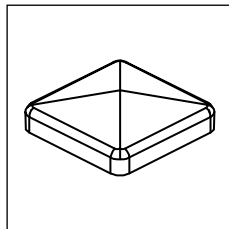

30 01 61 73/74
Topo piramidal 65x65
(branco/preto)

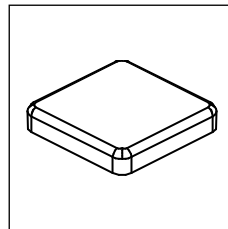

30 01 61 76/77
Topo liso 60x60 (branco/
preto)

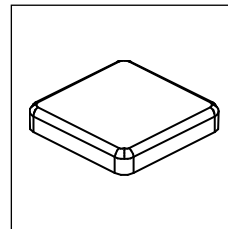

30 01 61 79/80
Topo liso 65x65 (branco/
preto)

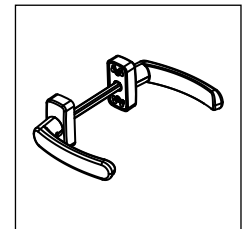

30 92 22 82/83
Puxador duplo (branco/
preto)

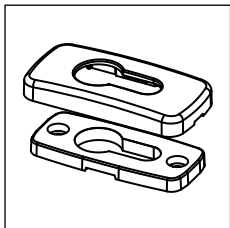

30 92 22 85/86
Escudo para canhão
(branco/preto)

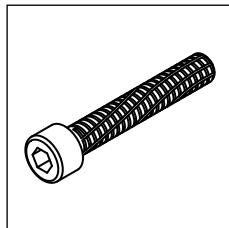

31 01 60 00
Parafuso M8x50
dacromet

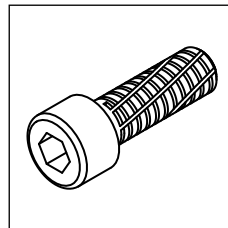

31 01 60 01
Parafuso M8x25
dacromet

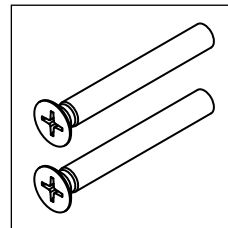

31 01 60 02
Jogo parafusos M5x45
A2

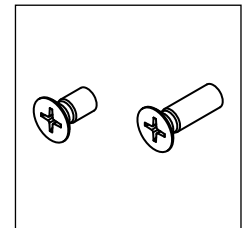

31 01 60 03
Jogo parafusos M5 A2

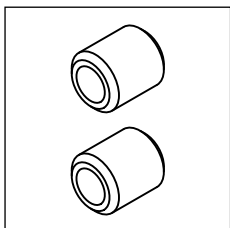

31 01 60 04
Jogo separador 714

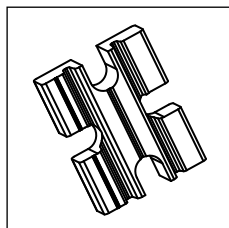

31 01 60 09
Calço de alumínio de
aperto

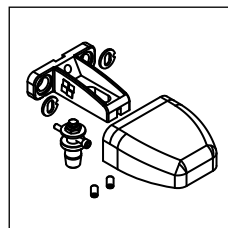

31 01 60 12 *
Pivot superior E20
(bruto)

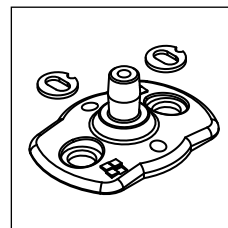

31 01 60 15 *
Pivot inferior E20 (bruto)

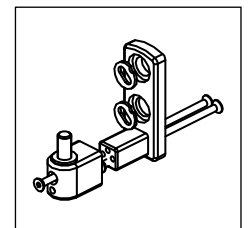

31 01 60 22 *
Conjunto pivot E12
(bruto)

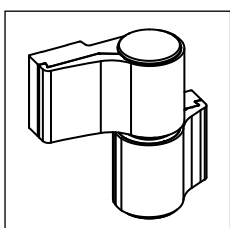

31 01 60 32
Dobradiça 2 abas 3D lisa
(bruto)

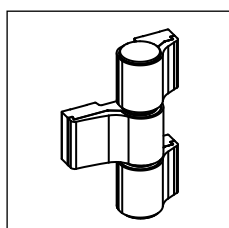

31 01 60 35
Dobradiça 3 abas 3D lisa
(bruto)

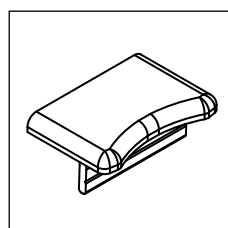

31 01 60 42
Topo PO-11 + PO-22
(bruto)

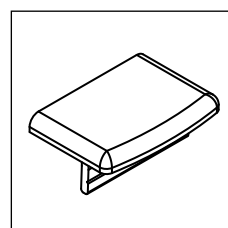

31 01 60 45
Topo PO-11 (bruto)

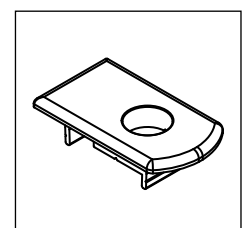

31 01 60 48
Topo PO-13 + PO-21
E20 (bruto)

* Só para lacar

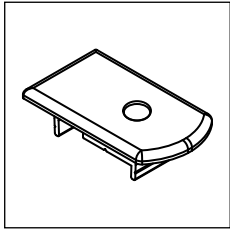

31 01 60 51
Topo PO-13 + PO-21
E12 (bruto)

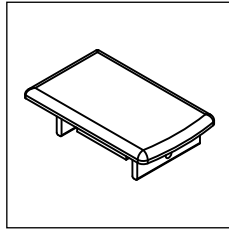

31 01 60 54
Topo PO-13 (bruto)

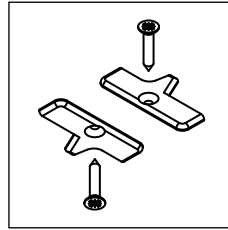

31 01 60 57
Jogo topos inversor
PO-20 (bruto)

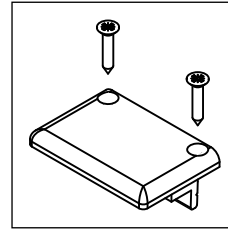

31 01 60 60
Topo fixo para
gradeamento (bruto)

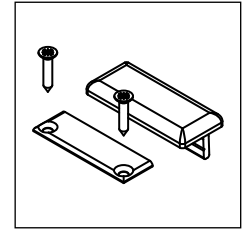

31 01 60 63
Jogo topos reg. para
gradeamento (bruto)

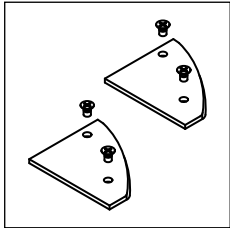

31 01 60 66
Jogo topos guia PO-19
(bruto)

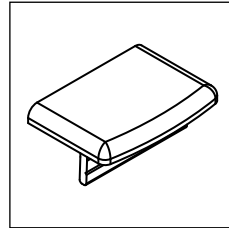

31 01 60 70
Topo prumo PO-04
(bruto)

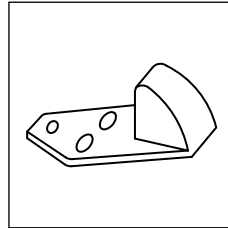

31 01 60 84 *
Batente central abertura
motorizada (bruto)

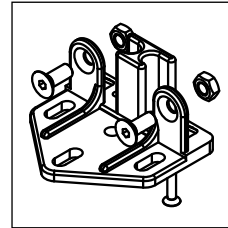

31 01 61 32 *
Fixador para ponte
PO-18 (bruto)

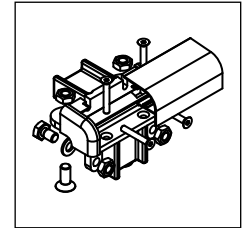

31 01 61 36 *
Ângulo para ponte PO-18
(bruto)

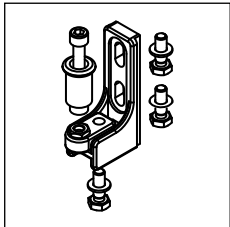

31 01 61 39 *
Suporte regulável para
rolete (bruto)

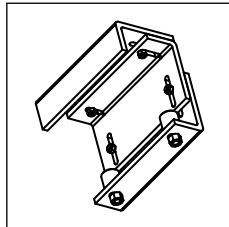

31 01 61 42
Ponte com roletos 30
mm (bruto)

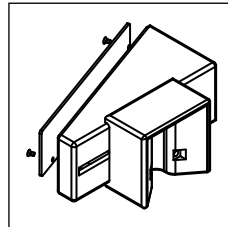

31 01 61 52 *
Conjunto de fecho correr
(bruto)

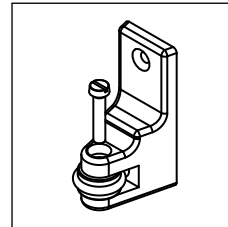

31 01 61 55 *
Engate para fecho correr
(bruto)

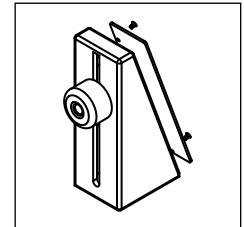

31 01 61 59 *
Batente correr (bruto)

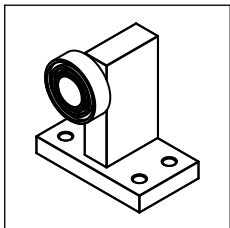

31 01 61 62
Batente correr alumínio
(bruto)

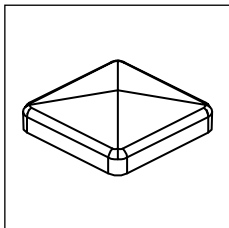

31 01 61 72 *
Topo piramidal 60x60
(bruto)

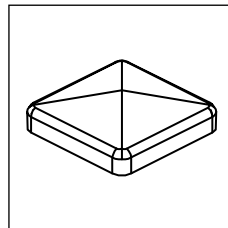

31 01 61 75 *
Topo piramidal 65x65
(bruto)

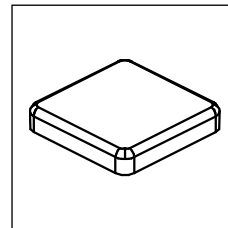

31 01 61 78 *
Topo liso 60x60 (bruto)

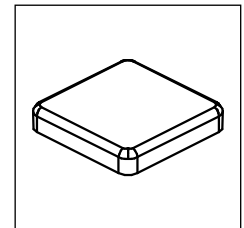

31 01 61 81 *
Topo liso 65x65 (bruto)

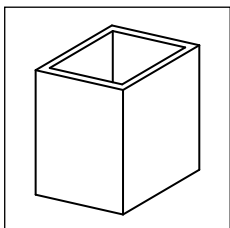

31 01 61 82 *
Fixador pavimento 60x60
(bruto)

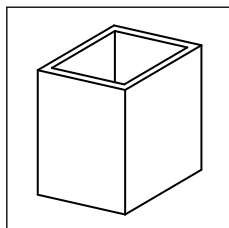

31 01 61 85 *
Fixador pavimento 65x65
(bruto)

Referência	Desenho	Descrição
30 01 62 00		Junta para inversor (preto)
30 60 00 14		Perfil pelúcia 18 mm (3 mts preto)
30 60 00 20		Perfil pelúcia 29 mm (3 mts preto)
30 80 10 22		Junta cunha recartilhada 7 mm
30 93 00 65		Junta cunha 5 mm (preto)
30 93 00 66		Junta cunha 4 mm (preto)
30 93 00 67		Junta cunha 2 mm (preto)
30 93 00 68		Junta cunha 6/7 mm (preto)
30 93 00 69		Junta cunha 8/9 mm (preto)
30 94 01 48		Junta de correr
30 95 00 10		Pelúcia Stop-Fin

Lp = Largura espaço para o portão
 Lf = Largura da folha
 LTpc = Largura do portão de correr
 Lg = Largura do gradeamento

Hp = Altura do portão
 Hpilar = Altura do pilar de sustentação
 HTP = Altura do portão incluído pivot (batente) ou ponte (correr)

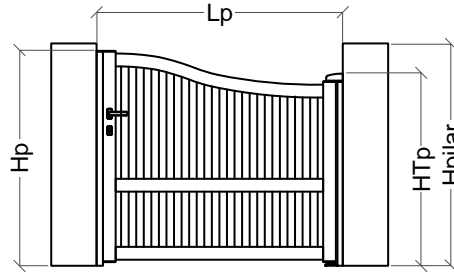
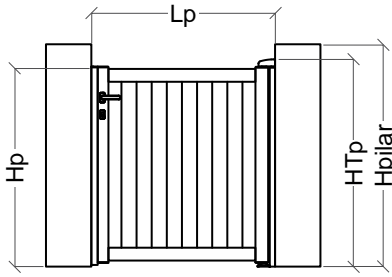

Portão de 1 Folha

Dimensões mínimas:
 Lp mini: 600 mm
 Hp mini: 600 mm
 Hpilar > 100 mm (mínimo) que HTP ou Hpilar > 100 mm (mínimo) que Hp

Dimensões máximas*:
 Lp maxi: 1600 mm
 Hp maxi: 2200 mm

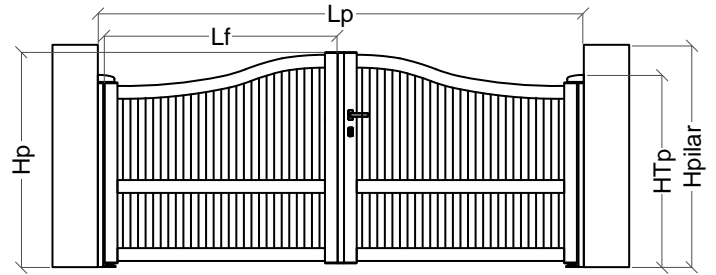
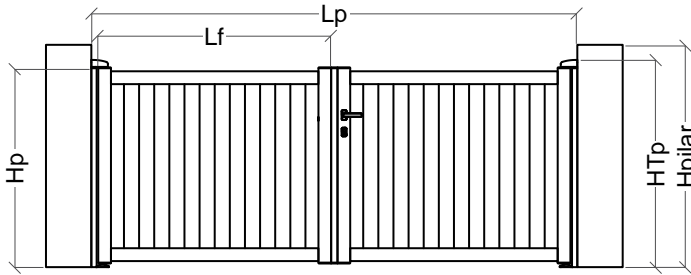

Portão de 2 Folhas

Dimensões mínimas:
 Lp mini: 1200 mm
 Hp mini: 600 mm
 Hpilar > 100 mm (mínimo) que HTP ou Hpilar > 100 mm (mínimo) que Hp

Dimensões máximas*:
 Lp maxi: 5500 mm - Lf maxi = 2716 mm
 Hp maxi: 2000 mm

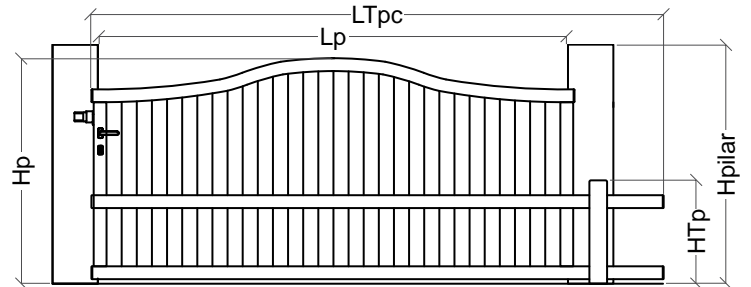
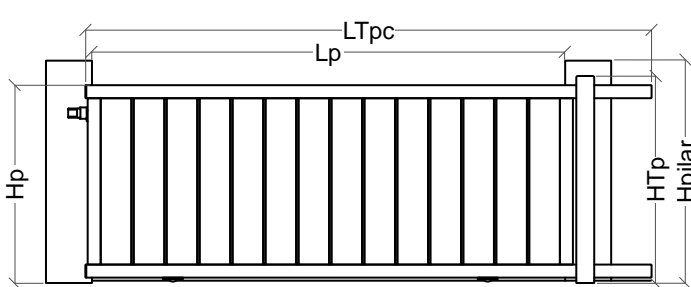

Portão de Correr

Dimensões mínimas:
 Lp mini: 600 mm
 Hp mini: 600 mm
 Hpilar > 100 mm (mínimo) que HTP ou Hpilar > 100 mm (mínimo) que Hp
 Peso máximo: 300 kg

Dimensões máximas*:
 Lp maxi: 4000 mm (com 2 rodas) ou 4001 mm - 6000 mm (com 4 rodas)
 Hp maxi: 2200 mm

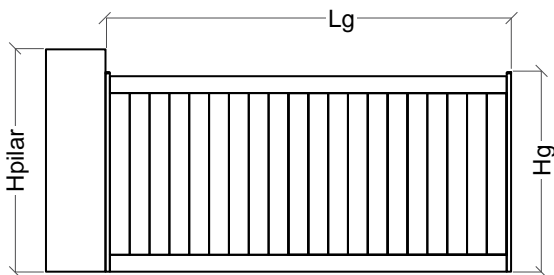

Gradeamento

Dimensões mínimas:
 Lg mini: 264 mm
 Hg mini: 250 mm

Dimensões máximas*:
 Lg maxi: 6500 mm
 Hg maxi: 2200 mm

Portão de 1 Folha Abrir com Dobradiças

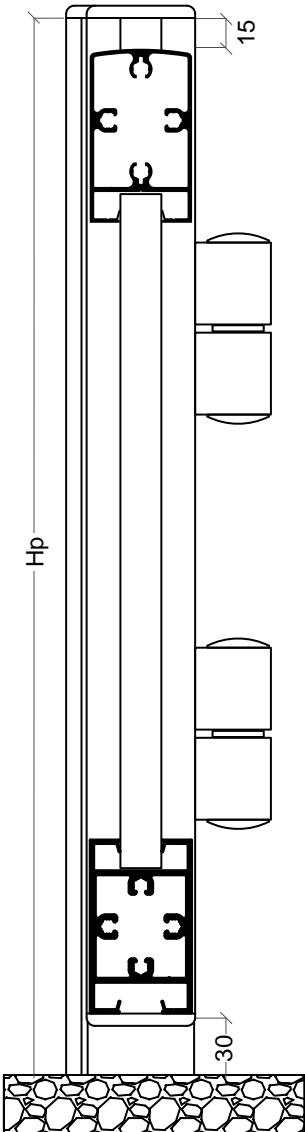
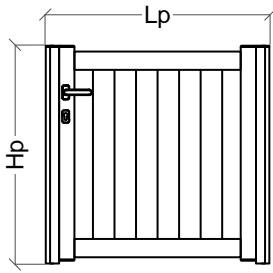

Perfis

Desenho	Ref	Descrição	Corte	Quant	Medida
	PO-11	Aro fixo		1	Hp
	PO-12	Travessa		1	Lp-264 mm
	PO-13	Montante		2	Hp-30 mm
	PO-14	Tampa		2	Hp-30 mm
	PO-16	Travessa inferior		1	Hp-264 mm
	PO-20	Inversor		2	Hp
	PO-25	Perfil tampa		2	20 mm
	W-27	Lâmina		várias	Hp-186 mm

Acessórios e Juntas

Referência	Descrição	Quantidade
30 01 60 30	Dobradiça 2 abas 3D lisa (Hp < 1500 mm)	2
30 01 60 43	Topo PO-11	2
30 01 60 52	Topo PO-13	4
30 01 60 55	Jogo topo inversor	2
30 01 60 90	Fechadura prumo	1
30 01 61 00	Canhão cromado	1
30 01 61 10	Testa elétrica	1
30 01 62 00	Junta inversor	2Hp
30 92 22 82	Puxador duplo	1
30 92 22 85	Escudo para canhão	2
31 01 60 00	Parafuso M8x50 dacromet	16
31 01 60 09	Calço de aperto	4

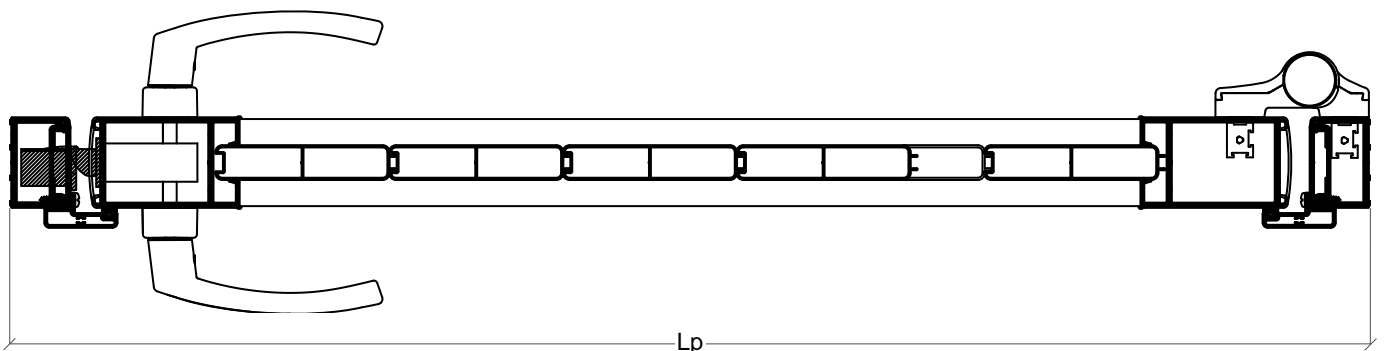

Portão de 2 Folhas Abrir com Conjunto Pivot E20

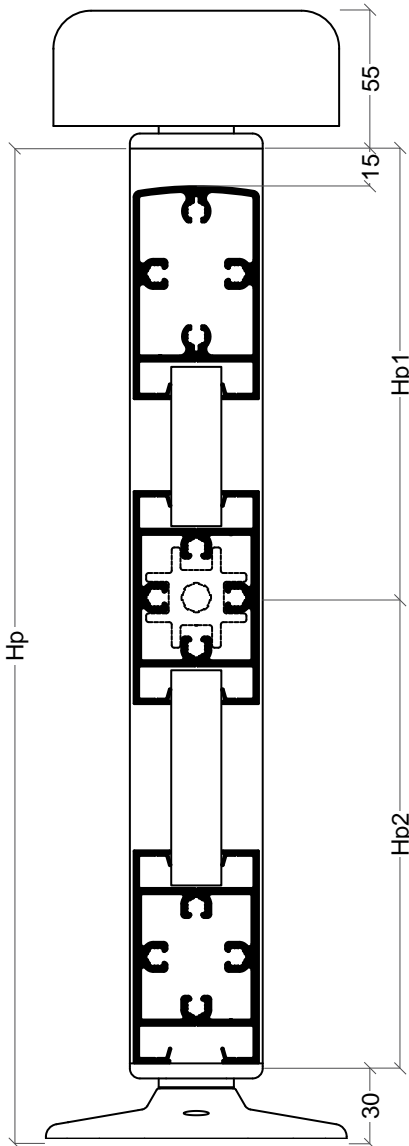
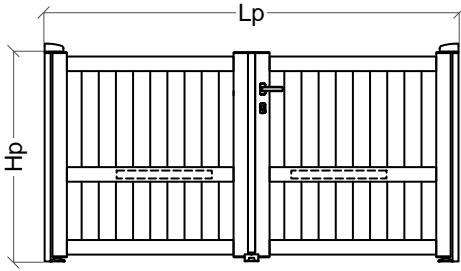

Perfis

Desenho	Ref	Descrição	Corte	Quant	Medida
	PO-11	Aro fixo		2	Hp
	PO-12	Travessa		2	Lp/2-220 mm
	PO-13	Montante		2	Hp-30 mm
	PO-14	Tampa		1	Hp-30 mm
	PO-16	Travessa intermédia		4	Lp/2-220 mm
	PO-20	Inversor		1	Hp-30 mm entalhe no extremo inferior
	PO-21	Suplemento		2	Hp-30 mm
	PO-22	Suplemento		2	Hp
	PO-25	Perfil tampa		4	20 mm
	W-27	Lâmina		várias	Hp1-114 mm
				várias	Hp2-129 mm
	PO-17	Perfil de reforço (para automatismo)		2	800 mm

Acessórios e Juntas

Referência	Descrição	Quantidade	
		Manual	Motorizado
30 01 60 10	Pivot superior	2	
30 01 60 13	Pivot inferior	2	
30 01 60 19	Casquilho nylon E20	4	
30 01 60 40	Topo PO-11 + PO-22	2	
30 01 60 46	Topo PO-13 + PO-21 E20	4	
30 01 60 52	Topo PO-13	4	
30 01 60 55	Jogo topos inversor PO-20	1	
30 01 60 80	Batente central (manual)	1	-
30 01 60 81	Batente central (motorizado)	-	1
30 01 60 90	Fechadura prumo	1	-
30 01 61 00	Canhão cromado	1	-
30 01 62 00	Junta para inversor		Hp
30 92 22 82	Puxador duplo	1	-
30 92 22 85	Escudo para canhão	2	-
30 95 00 10	Pelúcia Stop-Fin		2Hp
31 01 60 00	Parafuso M8x50 dacromet		48
31 01 60 09	Calço de aperto		12

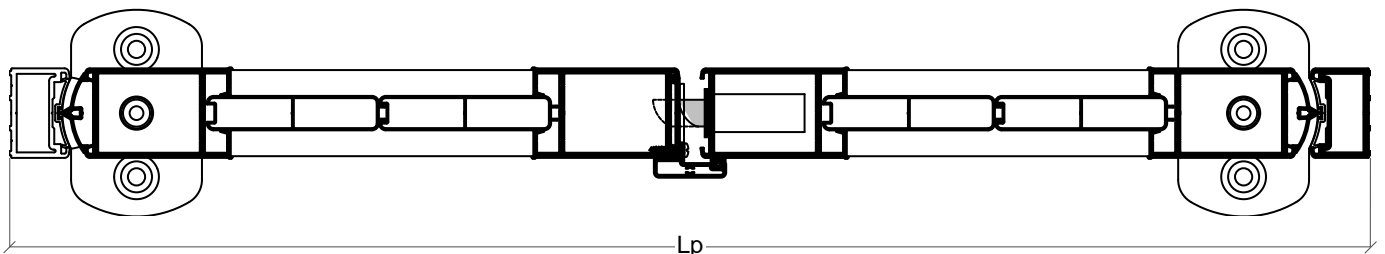

Portão de Correr com Roletos Especiais

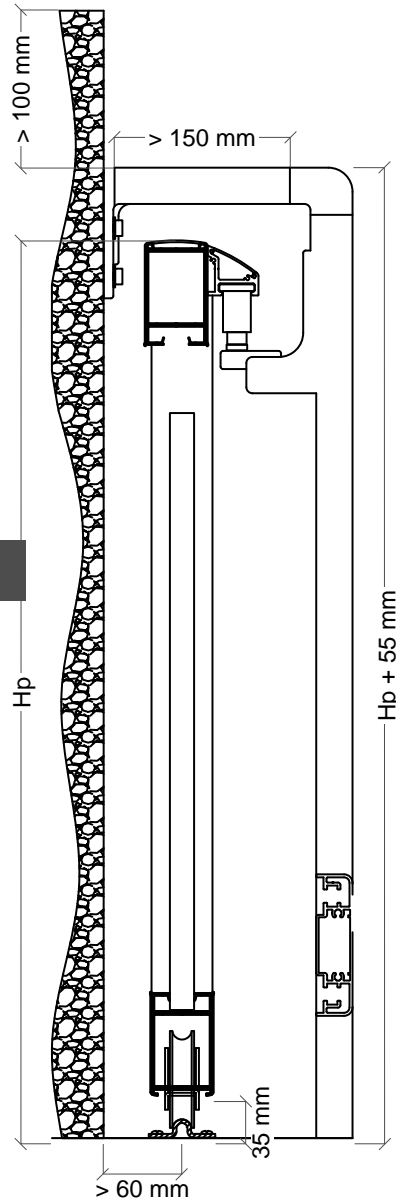
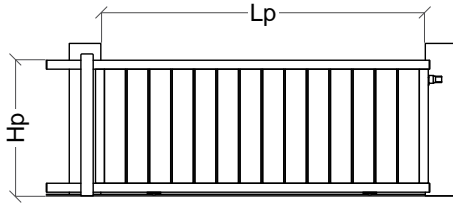

Perfis

Desenho	Ref	Descrição	Corte	Quant	Medida	
					Manual	Motorizado
	PO-13	Perfil para travessas		2	Lp+200 mm	Lp+500 mm
	PO-14	Tampa superior		2	Lp+200 mm	Lp+500 mm
	PO-16	Perfil para prumos		2	Hp-206 mm	
	PO-18	Ponte para roletos especiais		1	Hp+16 mm	
	PO-18	Ponte para roletos especiais		1	>150 mm	
	PO-19	Guia para roletos especiais		1	Lp+200 mm	Lp+500 mm
	PO-25	Perfil tampa		2	Hp-206 mm	
	PO-25	Perfil tampa		2	160 mm	400 mm
	W-12	Lâmina de 200 mm		várias	Hp-178 mm	
	W-16	Lâmina de 20 mm		várias	Hp-178 mm	

Acessórios e Juntas

Referência	Descrição	Quantidade	
		Manual	Motorizado
30 01 60 52	Topo PO-13	4	
30 01 60 64	Jogo topos PO-19	1	
30 01 60 96	Fechadura semi-automática	1	-
30 01 61 00	Canhão	1	-
30 01 61 21	Roda com suporte inferior	2 (Lp>4000 mm = 4)	
30 01 61 26	Calha de aço em U (6 mts)	Lp x 2 + 500 mm	
30 01 61 27	União para calha	1	
30 01 61 30	Fixador para PO-18	1	
30 01 61 33	Fixador interior para PO-18	1	
30 01 61 34	Ângulo para PO-18	1	
30 01 61 37	Suporte regulável para roletos	2	
30 01 61 50	Conjunto fecho correr	1	
30 01 61 53	Engate para fecho correr	-	1
30 01 61 56	Gache fecho correr	1	-
30 01 61 57	Batente correr	1	
30 92 22 82	Puxador duplo	1	-
30 92 22 85	Escudo para canhão	2	-
31 01 60 00	Parafuso M8x50	16	
31 01 60 02	Jogo parafuso M5x45	1	-
31 01 60 03	Jogo parafuso M5	1	-
31 01 60 04	Jogo separador 714	1	-
31 01 60 09	Calço de alumínio	4	

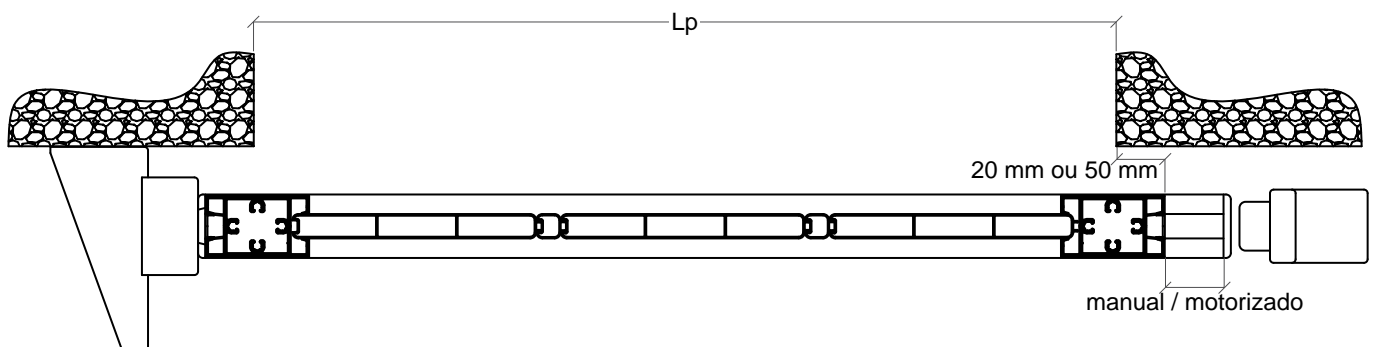

Portão de Correr com Roletos de 30 mm

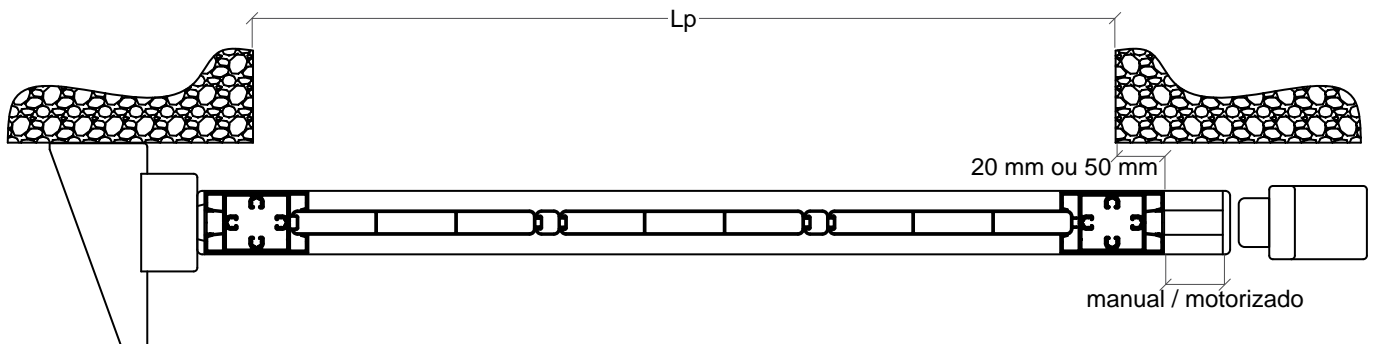
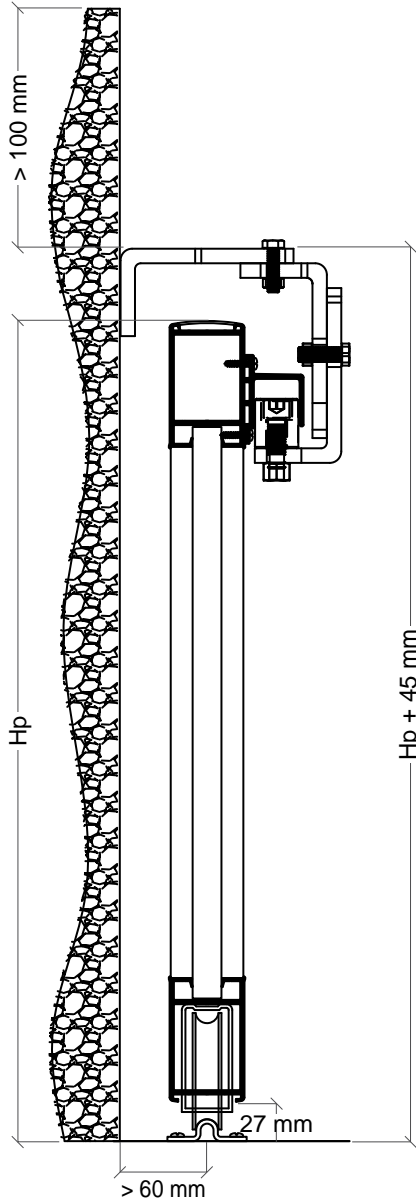
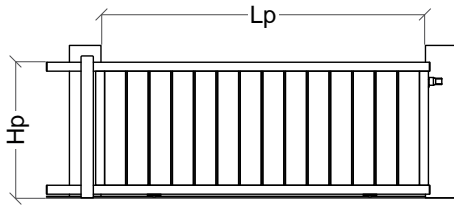

Perfis

Desenho	Ref	Descrição	Corte	Quant	Medida	
					Manual	Motorizado
	PO-13	Perfil para travessas		2	Lp+200 mm	Lp+500 mm
	PO-14	Tampa superior		1	Lp+200 mm	Lp+500 mm
	PO-16	Perfil para prumos		2	Hp-198 mm	
	PO-09	Guia para roletos 30 mm		1	Lp+200 mm	Lp+500 mm
	PO-25	Perfil tampa		2	Hp-198 mm	
	PO-25	Perfil tampa		2	160 mm	400 mm
	W-12	Lâmina de 200 mm		várias	Hp-170 mm	
	W-16	Lâmina de 20 mm		várias	Hp-170 mm	

Acessórios e Juntas

Referência	Descrição	Quantidade	
		Manual	Motorizado
30 01 60 52	Topo PO-13	4	
30 01 60 96	Fechadura semi-automática	1	-
30 01 61 00	Canhão	1	-
30 01 61 20	Roda com suporte triangular	2 (Lp>4000 mm = 4)	
30 01 61 26	Calha de aço um U (6 mts)	Lpx2+500 mm	
30 01 61 27	União para calha	1	
30 01 61 40	Ponte com roletos 30 mm	1	
30 01 61 50	Conjunto fecho correr	1	
30 01 61 53	Engate para fecho correr	-	1
30 01 61 56	Gache fecho correr	1	-
30 01 61 60	Batente correr alumínio	1	
30 92 22 82	Puxador duplo	1	-
30 92 22 85	Escudo para canhão	2	-
31 01 60 00	Parafuso M8x50	16	
31 01 60 02	Jogo parafuso M5x45	1	-
31 01 60 03	Jogo parafuso M5	1	-
31 01 60 04	Jogo separador 714	1	-
31 01 60 09	Calço de alumínio	4	

Gradeamento

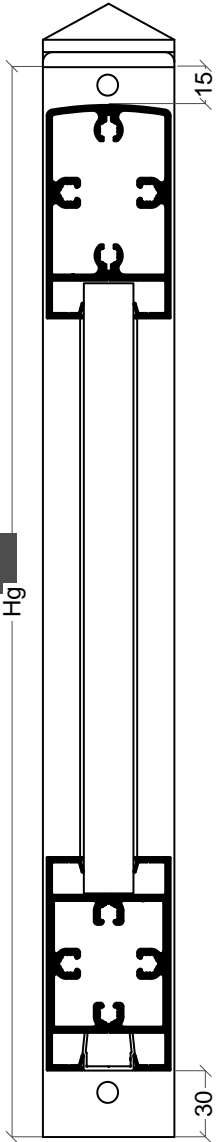
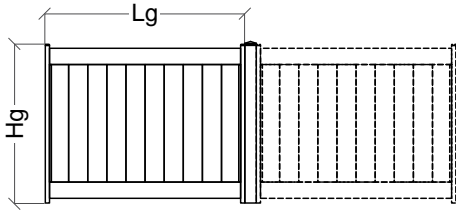

Perfis

Desenho	Ref	Descrição	Corte	Quant	Medida
	PO-12	Travessa		1	Lg-56 mm
	PO-16	Travessa inferior		1	Lg-56 mm
	PO-23	Remate gradeamento		2	Hg-2 mm
	PO-24	Remate gradeamento		2	Hg
	PO-25	Tampa de remate		1	Lg-56 mm
	W-27	Lâmina		várias	Hg-186 mm
	Q-20	Prumo		1	Hg+6 mm
	U-11	Remate lateral		2	Hg-215 mm

Acessórios e Juntas

Referência	Descrição	Quantidade
30 01 60 61	Jogo topos reguláveis	2
31 01 61 82	Fixador pavimento	1
30 01 61 70	Topo piramidal 60x60	1
31 01 60 01	Parafuso M8x25 dacromet	8

14

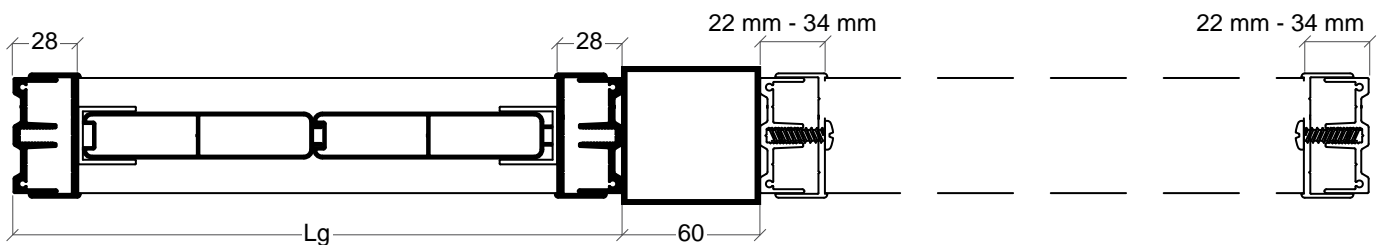

Exemplos de Tipologias possíveis

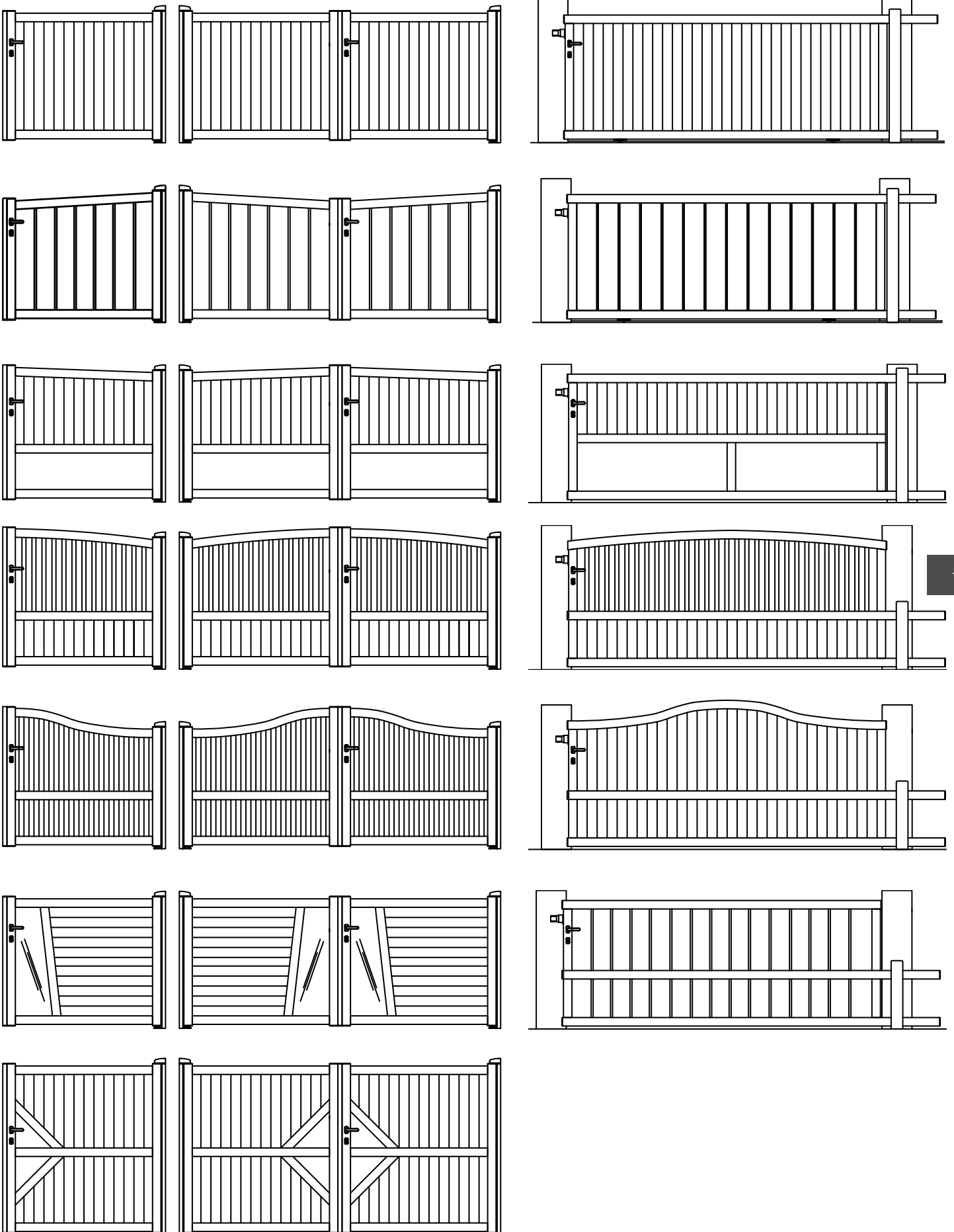

Pormenores de Montagem

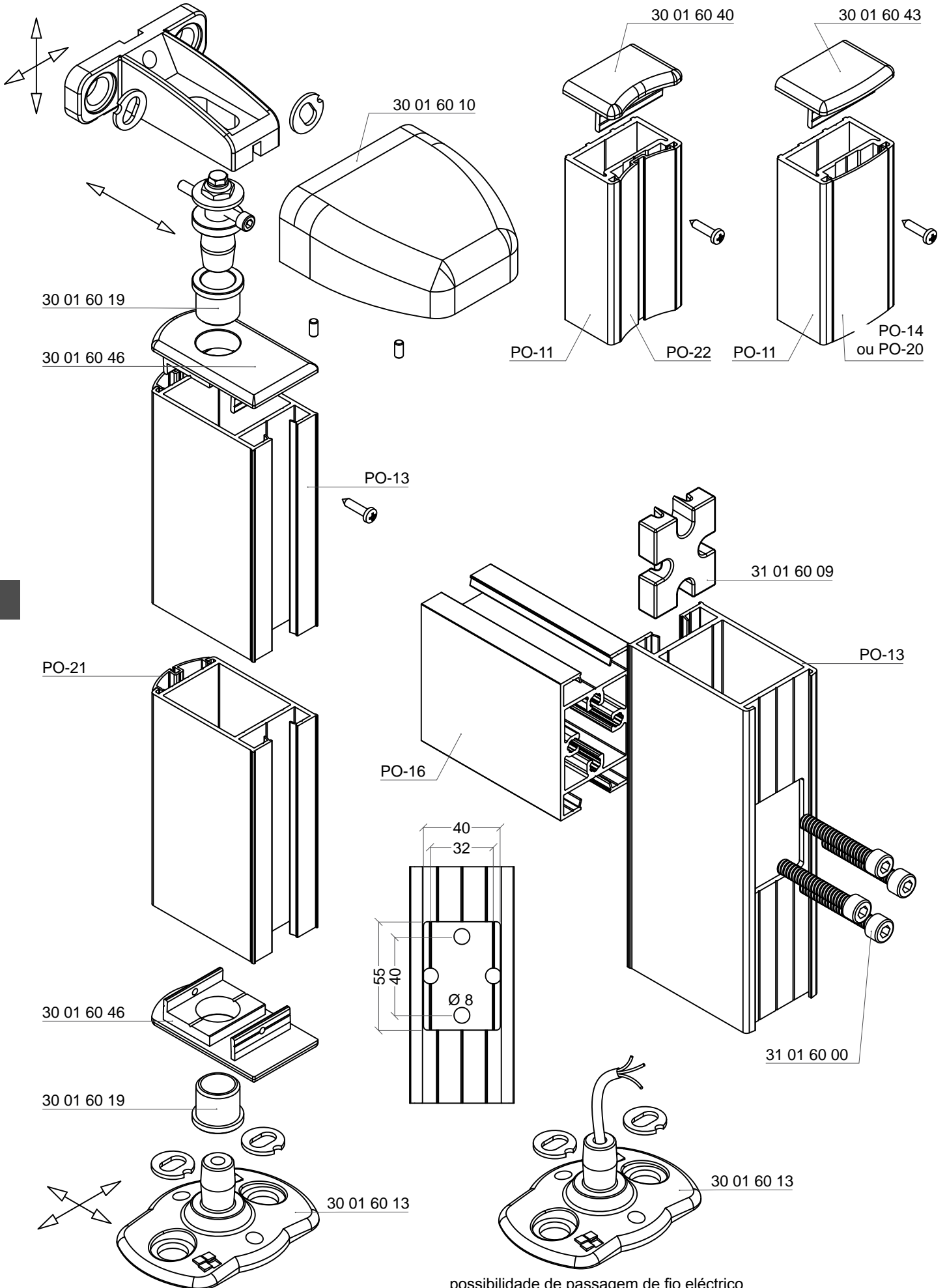

Pormenores de Montagem

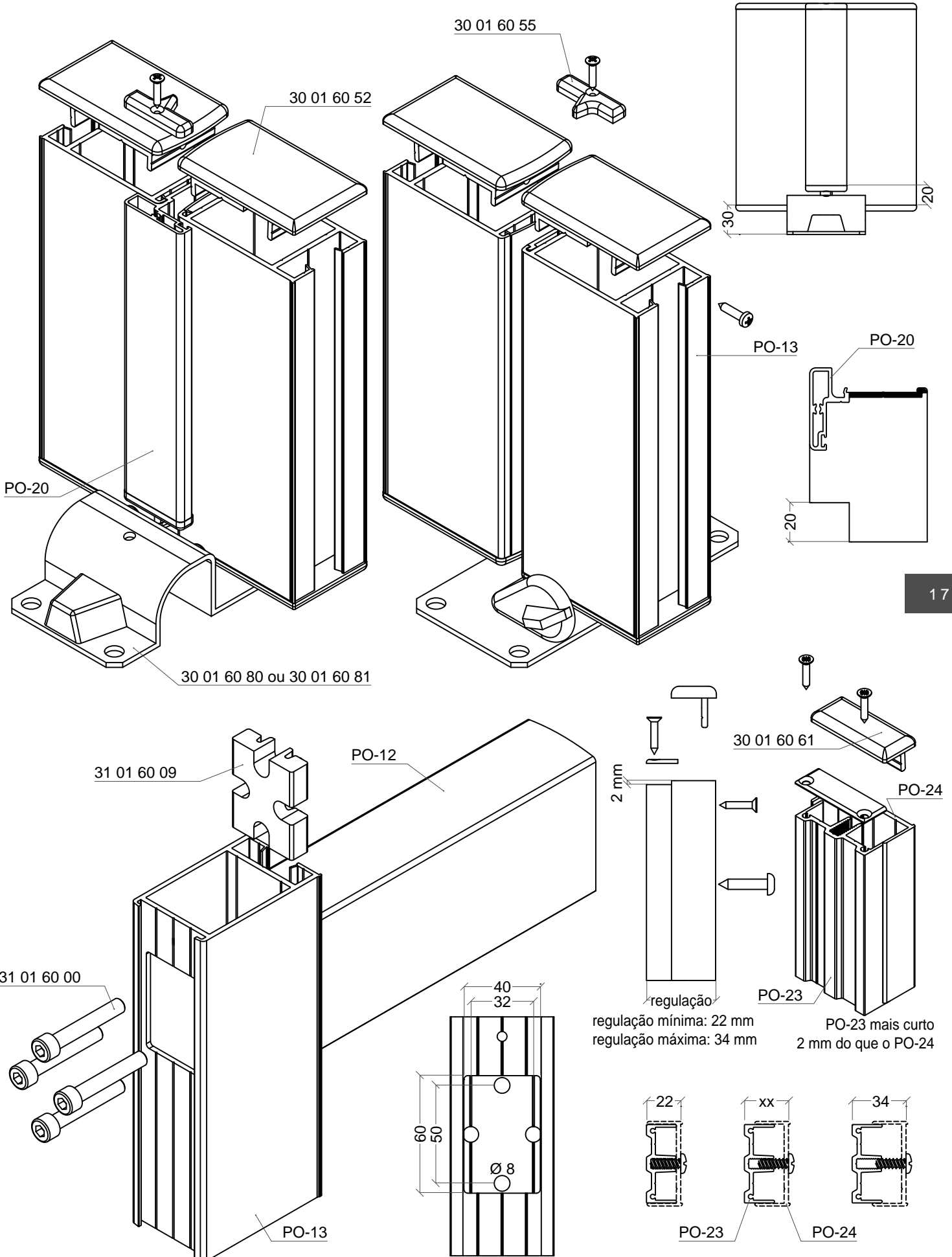

Pormenores de Montagem

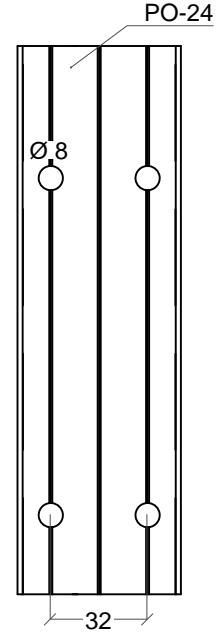
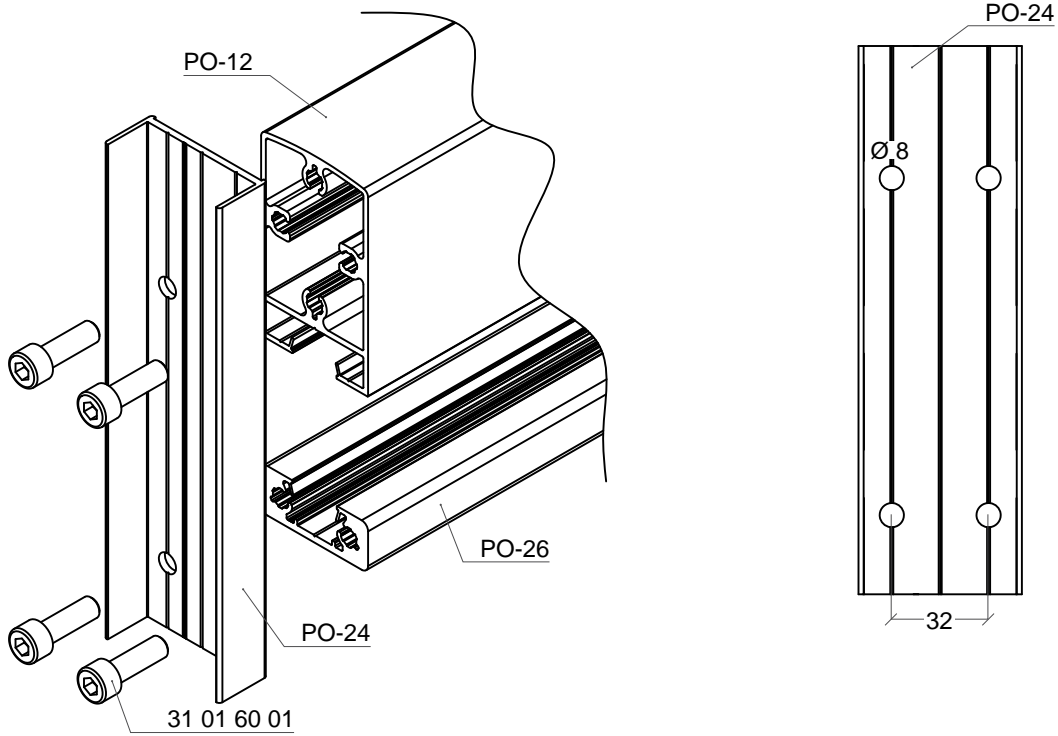

18

