

www.dineru.com

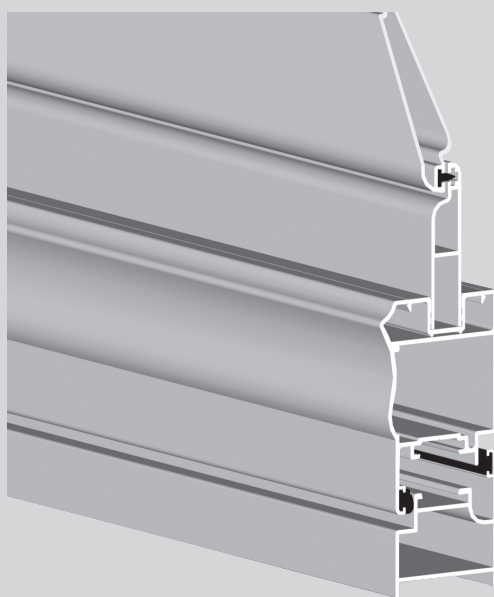

SISTEMAS DE PORTADA



Sistema
BE

Sistema BE

Sistema de Portadas

Características do sistema

Sistema de portada que oferece a possibilidade de dois tipos de lâminas:

- Lâminas fixas
- Lâminas orientáveis

As lâminas orientáveis permitem uma total regulação através de mecanismos de rotação que permitem assim um controle da luminosidade de interior.

Perfis de alumínio

As secções do aro e do móvel são ambas de 40 mm, com uma espessura média dos perfis de alumínio de 1.5 mm.

Dimensionamento e manobralidade

Possibilidades de abertura: exterior (1, 2 ,3 e 4 folhas);

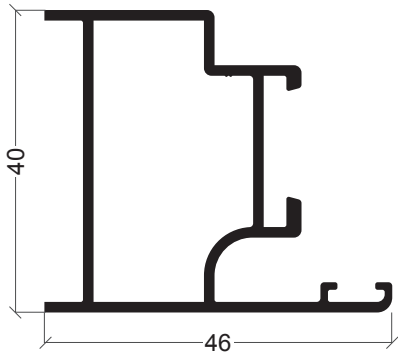

BE-01
Aro fixo

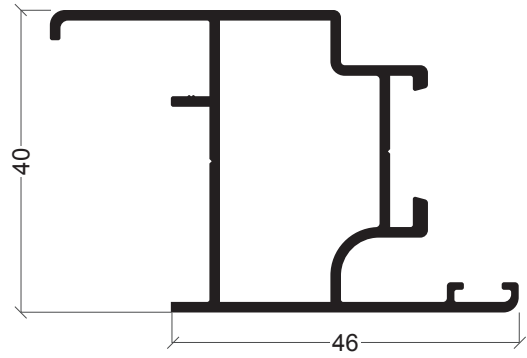

BE-27
Aro fixo com remate

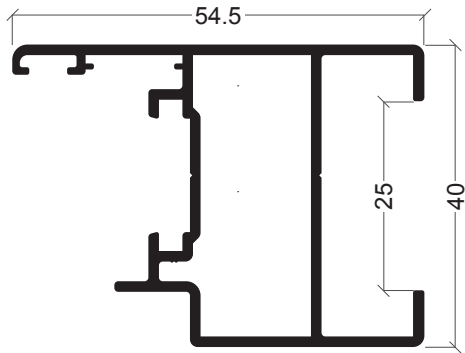

BE-19
Aro móvel caixa 25 mm

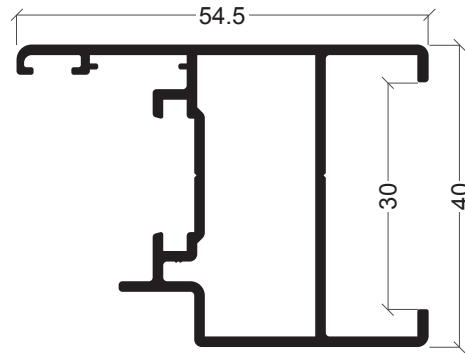

BE-03
Aro móvel caixa 30 mm

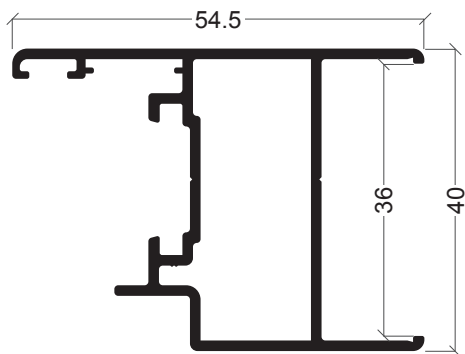

BE-02
Aro móvel caixa 36 mm

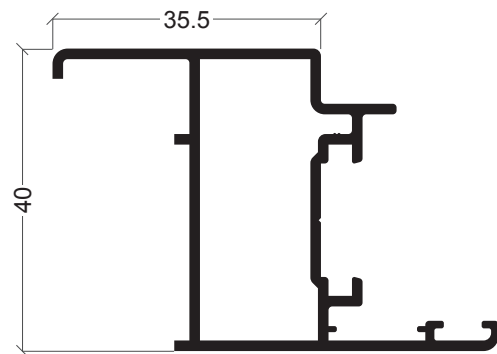

BE-17
Aro fixo com remate

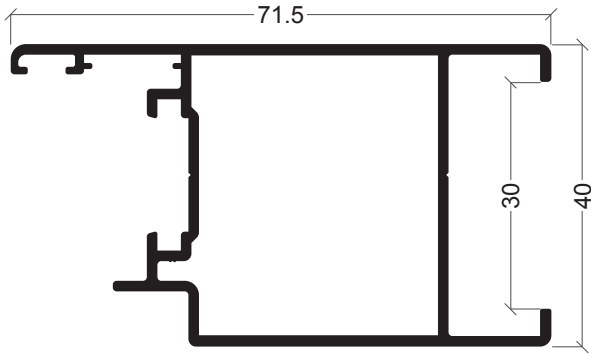

BE-22
Aro móvel caixa 30 mm

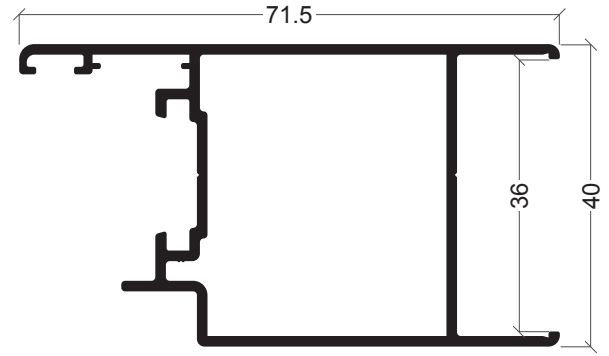

BE-23
Aro móvel caixa 36 mm

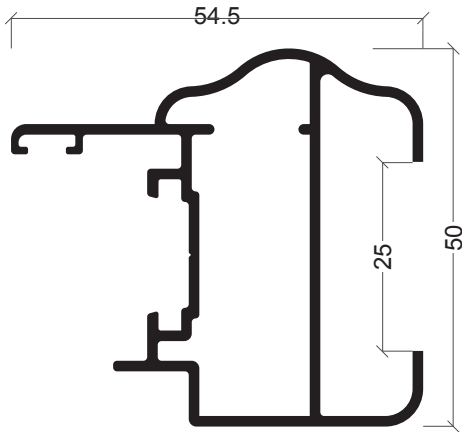

BE-20
Aro móvel decorativo caixa 25 mm

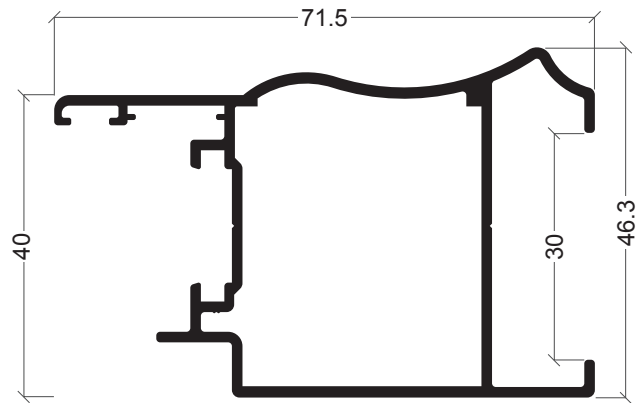

BE-24
Aro móvel decorativo caixa 36 mm

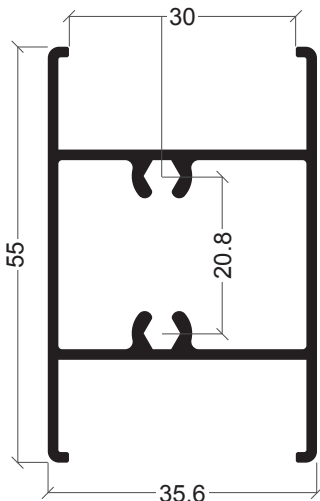

BE-05
Travessa caixa 30 mm

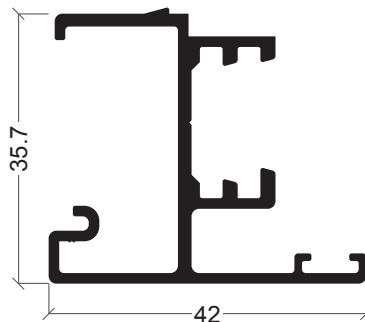

BE-04
Inversor

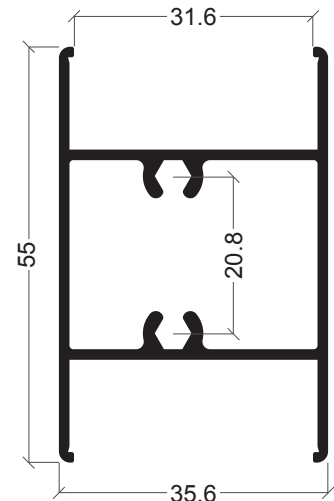

BE-06
Travessa caixa 31.6 mm

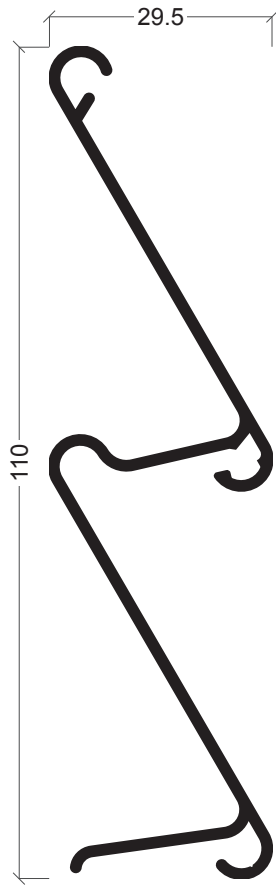

Z-34
Lâmina fixa

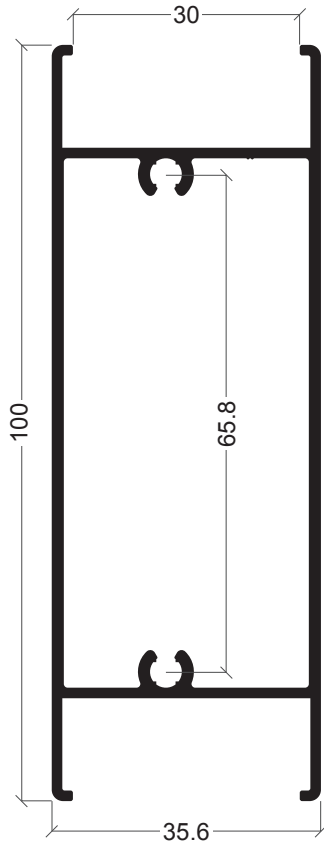

BE-09
Travessa caixa 30 mm

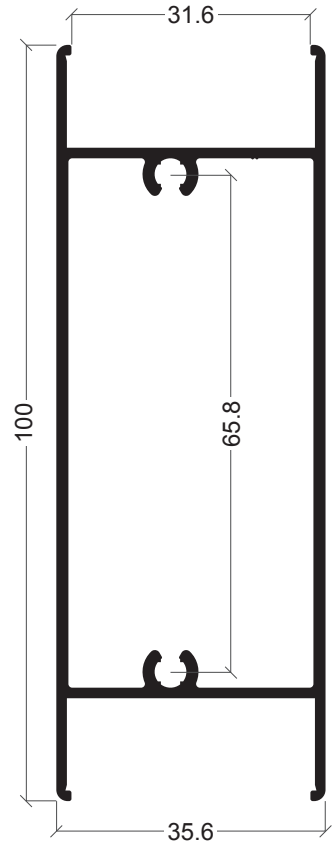

BE-10
Travessa caixa 31.6 mm

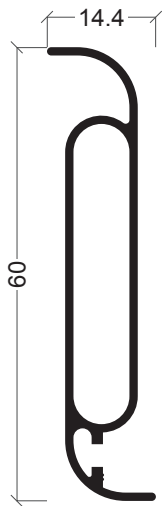

Z-52
Lâmina móvel

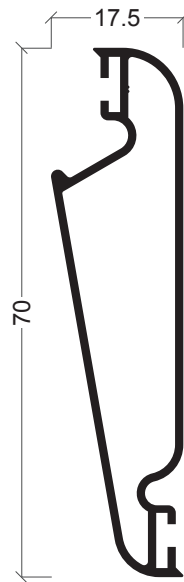

Z-53
Lâmina móvel

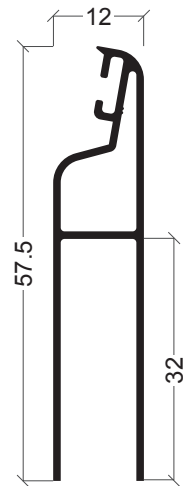

Z-54
Meia lâmina 32 mm

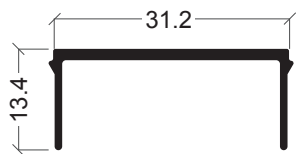

BE-12
Calha fecho

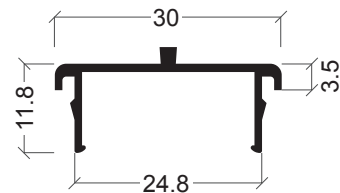

BE-18
Calha comando

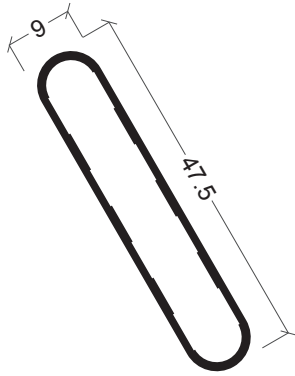

Z-35
Lâmina fixa

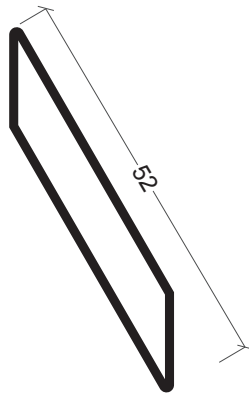

Z-40
Lâmina fixa

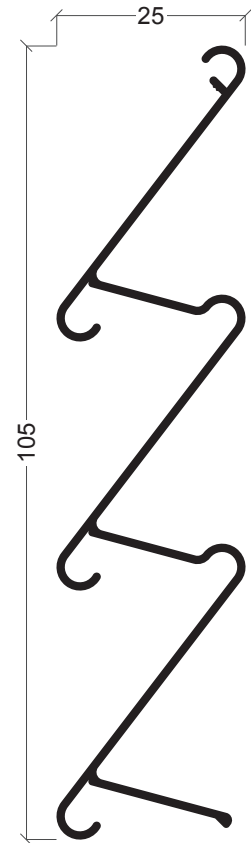

Z-20
Lâmina fixa

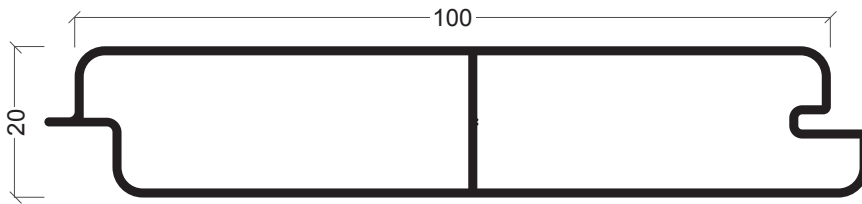

W-25
Lâmina de encaixe 100 x 20

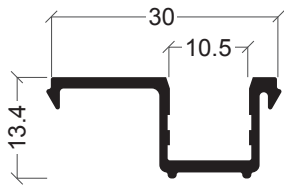

BE-26
Calha fecho

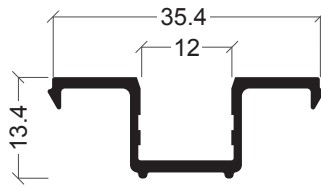

BE-15
Compensador

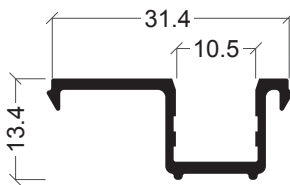

BE-11
Compensador

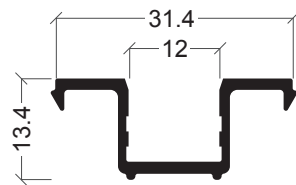

BE-16
Compensador

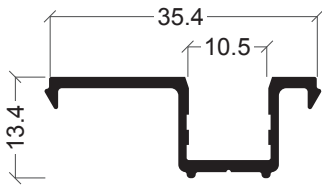

BE-08
Compensador

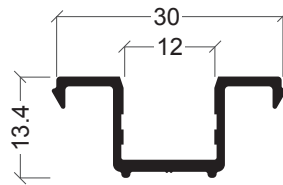

BE-25
Compensador

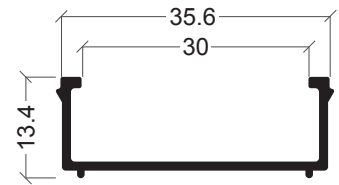

BE-14
Redutor

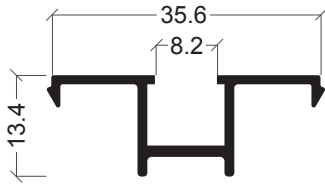

BE-07
Compensador

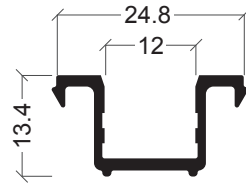

BE-21
Compensador

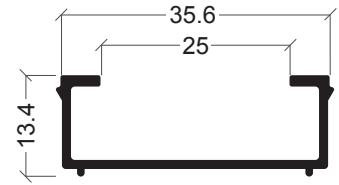

BE-13
Redutor

Janela 1 folha abertura exterior

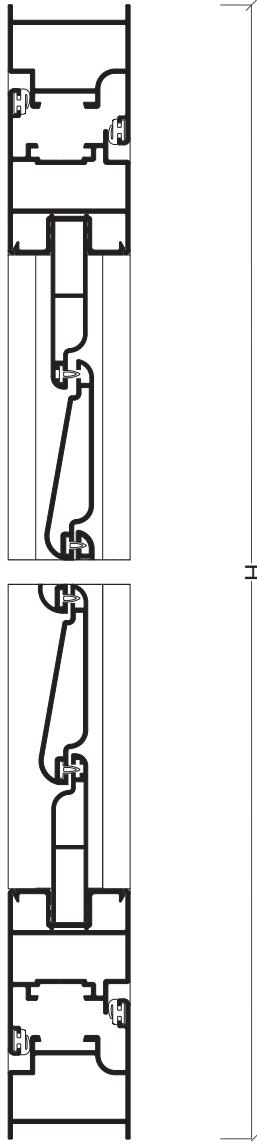
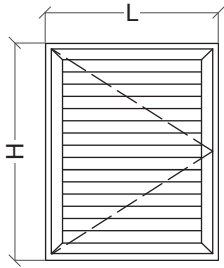

Perfis

| Desenho | Ref | Descrição | Corte | Quant | Medida |
|---------|-------|-------------|-------|----------------|--------------|
| | BE-01 | Aro fixo | | 2 | L |
| | | | | 2 | H |
| | BE-02 | Aro móvel | | 2 | L-55 mm |
| | | | | 2 | H-55 mm |
| | BE-15 | Compensador | | 2 | L-164 mm |
| | Z-53 | Lâmina | | Segundo altura | L-184 mm |
| | Z-54 | Meia lâmina | | 2 | L-184 mm |
| | AX-19 | Vareta | | 2 | Apro. H/2 mm |

Acessórios e Juntas

| Referência | Descrição | Quantidade |
|-------------|------------------------------------|--------------------|
| --- | Dobradiça aro fixo | 3 |
| 31 02 70 01 | Esquadro janela | 8 |
| 30 94 01 38 | Cremona abertura exterior | 1 |
| 30 94 01 39 | Kit fixação cremona | 1 |
| 30 94 01 40 | Parafuso de ligação | 2 |
| 30 92 00 40 | Terminal de fecho | 2 |
| --- | Contra-fecho aro fixo | 2 |
| 30 96 00 22 | Esquadro alinhamento | 4 |
| 30 94 01 09 | Fixador de portada | 1 |
| --- | Jogo portalaminas (segundo altura) | 1 |
| 30 92 09 60 | Comando rotativo | 1 |
| 31 02 60 50 | Junta de batente | 4L+4H |
| 30 93 01 40 | Junta para lamina | (nº laminas + 1) L |

Portalâminas

| |
|---------------|
| Hv = H-164 mm |
|---------------|

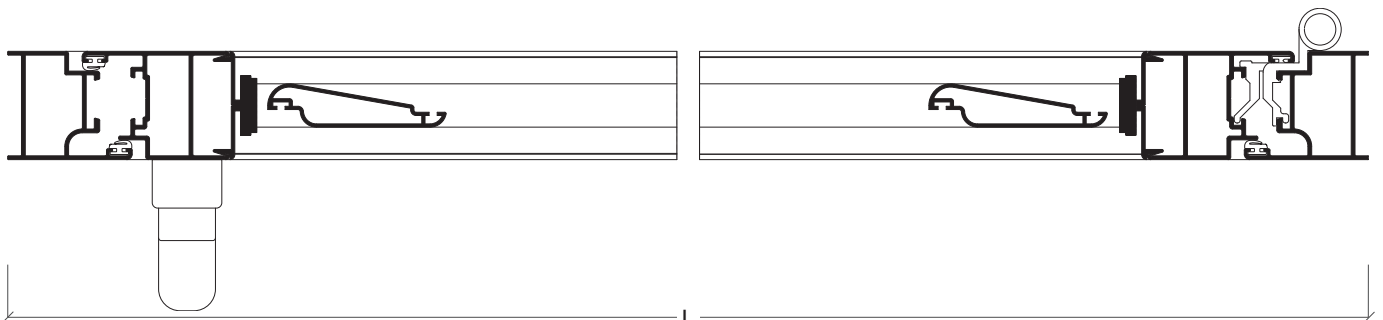

Janela 2 folhas abertura exterior

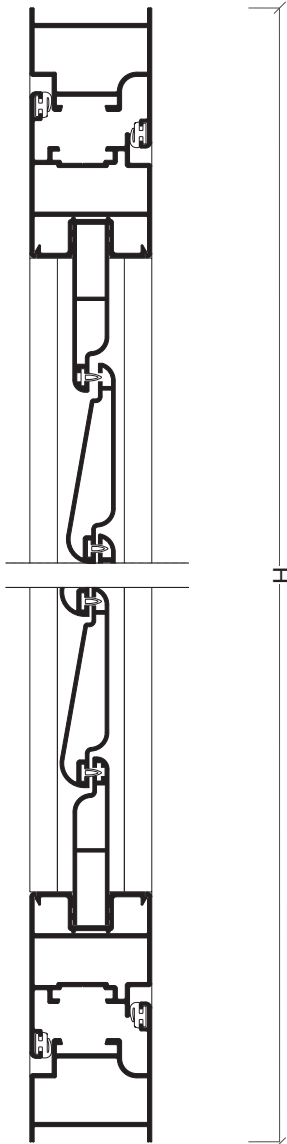
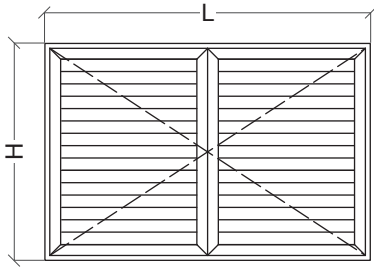

Perfis

| Desenho | Ref | Descrição | Corte | Quant | Medida |
|---------|-------|-------------|-------|----------------|--------------|
| | BE-01 | Aro fixo | | 2 | L |
| | | | | 2 | H |
| | BE-02 | Aro móvel | | 4 | L/2-30 mm |
| | | | | 4 | H-55 mm |
| | BE-04 | Inversor | | 1 | H-102 mm |
| | BE-15 | Compensador | | 4 | L/2-139 mm |
| | Z-53 | Lâmina | | Segundo altura | L/2-159 mm |
| | Z-54 | Meia lâmina | | 4 | L/2-159 mm |
| | AX-19 | Vareta | | 2 | Apro. H/2 mm |

Acessórios e Juntas

| Referência | Descrição | Quantidade |
|-------------|-----------------------------------|----------------------|
| --- | Dobradiça aro fixo | 6 |
| 31 02 70 01 | Esquadro janela | 12 |
| 30 94 01 38 | Cremona abertura exterior | 1 |
| 30 94 01 39 | Kit fixação cremone | 1 |
| 30 94 01 40 | Parafuso de ligação | 2 |
| 30 92 00 40 | Terminal de fecho | 2 |
| 31 02 60 04 | Jogo topos | 1 |
| 30 92 01 20 | Fecho 2ª folha | 1 |
| 30 96 00 22 | Esquadro alinhamento | 8 |
| --- | Contra-fecho aro fixo | 2 |
| 30 94 01 09 | Fixador de portada | 2 |
| --- | Jogo portalamina (segundo altura) | 2 |
| 30 92 09 60 | Comando rotativo | 2 |
| 31 02 60 50 | Junta de batente | 4L+6H |
| 30 93 01 40 | Junta para lamina | (nº laminas + 2) L/2 |

Portalamina

| |
|---------------|
| Hv = H-164 mm |
|---------------|

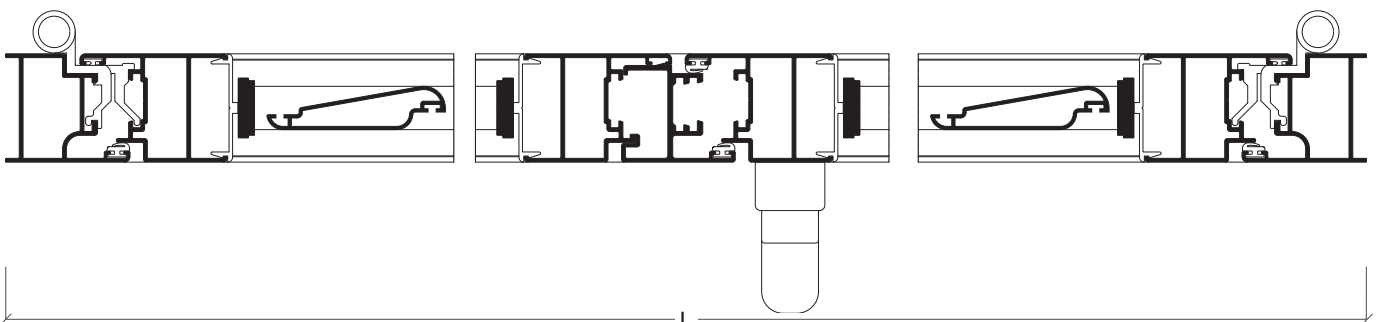

Janela 3 folhas abertura exterior

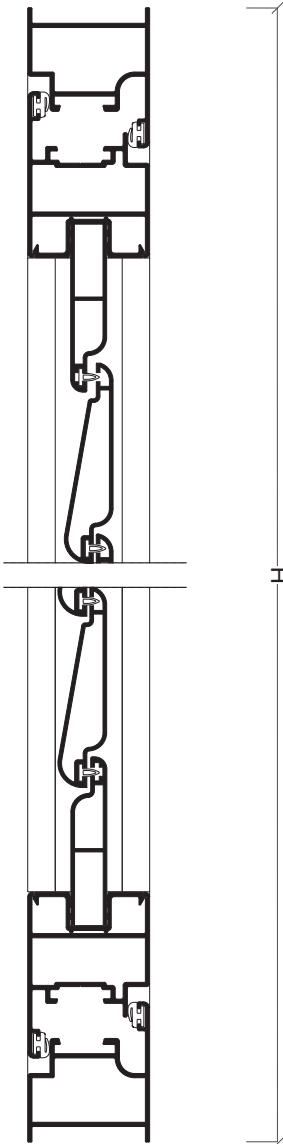
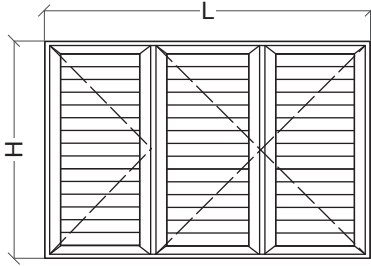

Perfis

| Desenho | Ref | Descrição | Corte | Quant | Medida |
|---------|-------|-------------|-------|----------------|---------------------|
| | BE-01 | Aro fixo | | 2 | L |
| | | | | 2 | H |
| | BE-02 | Aro móvel | | 4 | Lat. = L/3 mm |
| | | | | 2 | Centr. = L/3-65 mm |
| | | | | 6 | H-55 mm |
| | BE-04 | Inversor | | 2 | H-102 mm |
| | BE-15 | Compensador | | 4 | Lat. = L/3-109 mm |
| | | | | 2 | Centr. = L/3-174 mm |
| | Z-53 | Lâmina | | Segundo altura | Lat. = L/3-129 mm |
| | | | | Segundo altura | Centr. = L/3-194 mm |
| | Z-54 | Meia lâmina | | 4 | Lat. = L/3-129 mm |
| | | | | 2 | Centr. = L/3-194 mm |
| | AX-19 | Vareta | | 2 | Apro. H/2 mm |

Acessórios e Juntas

| Referência | Descrição | Quantidade |
|-------------|------------------------------------|----------------------|
| --- | Dobradiça aro fixo | 6 |
| --- | Dobradiça de balanço aro fixo | 3 |
| 31 02 70 01 | Esquadro janela | 16 |
| 30 94 01 38 | Cremona abertura exterior | 1 |
| 30 94 01 39 | Kit fixação cremona | 1 |
| 30 94 01 40 | Parafuso de ligação | 2 |
| 30 92 00 40 | Terminal de fecho | 2 |
| 31 02 60 04 | Jogo topos | 2 |
| 30 92 01 20 | Fecho 2ª folha | 2 |
| 30 96 00 22 | Esquadro alinhamento | 12 |
| --- | Contra-fecho aro fixo | 4 |
| 30 94 01 09 | Fixador de portada | 1 |
| 30 94 01 10 | Fixador de portada duplo | 1 |
| --- | Jogo portalaminas (segundo altura) | 3 |
| 30 92 09 60 | Comando rotativo | 3 |
| 31 02 60 50 | Junta de batente | 4L+8H |
| 30 93 01 40 | Junta para lamina | (nº laminas + 3) L/3 |

Portalâminas

| |
|---------------|
| Hv = H-164 mm |
|---------------|

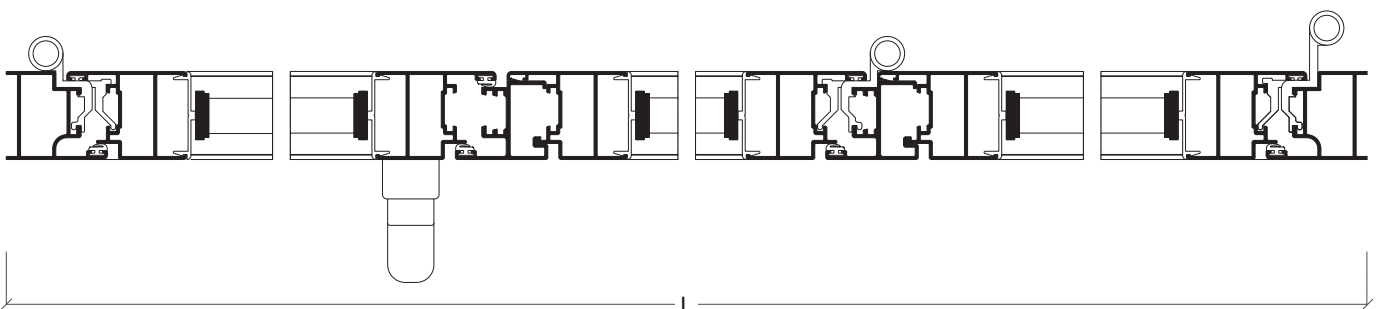

Janela 4 folhas abertura exterior

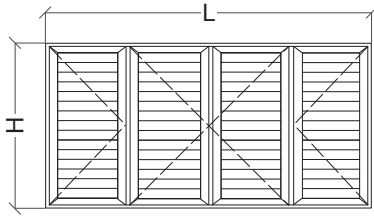

Perfis

| Desenho | Ref | Descrição | Corte | Quant | Medida |
|---------|-------|-------------|-------|----------------|---------------------|
| | BE-01 | Aro fixo | | 2 | L |
| | | | | 2 | H |
| | BE-02 | Aro móvel | | 4 | Lat. = L/4+10 mm |
| | | | | 4 | Centr. = L/4-45 mm |
| | | | | 8 | H-55 mm |
| | BE-04 | Inversor | | 3 | H-102 mm |
| | BE-15 | Compensador | | 4 | Lat. = L/4-119 mm |
| | | | | 4 | Centr. = L/4-154 mm |
| | Z-53 | Lâmina | | Segundo altura | Lat. = L/4-139 mm |
| | | | | Segundo altura | Centr. = L/4-174 mm |
| | Z-54 | Meia lâmina | | 4 | Lat. = L/4-139 mm |
| | | | | 4 | Centr. = L/4-174 mm |
| | AX-19 | Vareta | | 2 | Apro. H/2 mm |

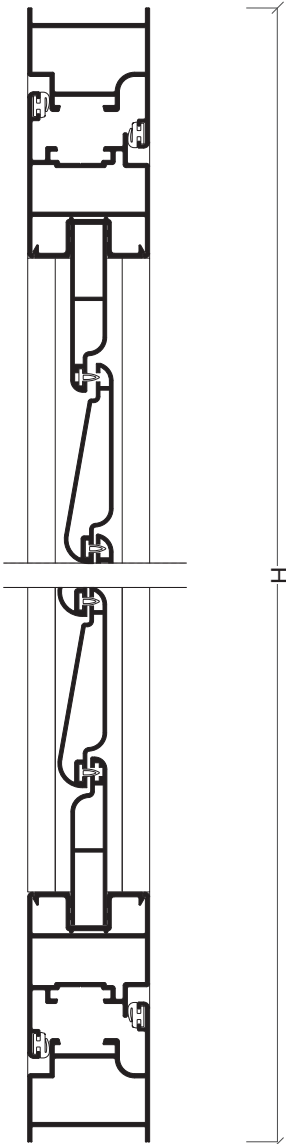

Acessórios e Juntas

| Referência | Descrição | Quantidade |
|-------------|------------------------------------|----------------------|
| --- | Dobradiça aro fixo | 6 |
| --- | Dobradiça de balanço aro fixo | 6 |
| 31 02 70 01 | Esquadro janela | 20 |
| 30 94 01 38 | Cremona abertura exterior | 1 |
| 30 94 01 39 | Kit fixação cremona | 1 |
| 30 94 01 40 | Parafuso de ligação | 2 |
| 30 92 00 40 | Terminal de fecho | 2 |
| 31 02 60 04 | Jogo topos | 3 |
| 30 92 01 20 | Fecho 2ª folha | 3 |
| 30 96 00 22 | Esquadro alinhamento | 16 |
| --- | Contra-fecho aro fixo | 6 |
| 30 94 01 10 | Fixador de portada duplo | 2 |
| --- | Jogo portalaminas (segundo altura) | 4 |
| 30 92 09 60 | Comando rotativo | 4 |
| 31 02 60 50 | Junta de batente | 4L+10H |
| 30 93 01 40 | Junta para lamina | (nº laminas + 4) L/4 |

Portalaminas

| |
|---------------|
| Hv = H-164 mm |
|---------------|

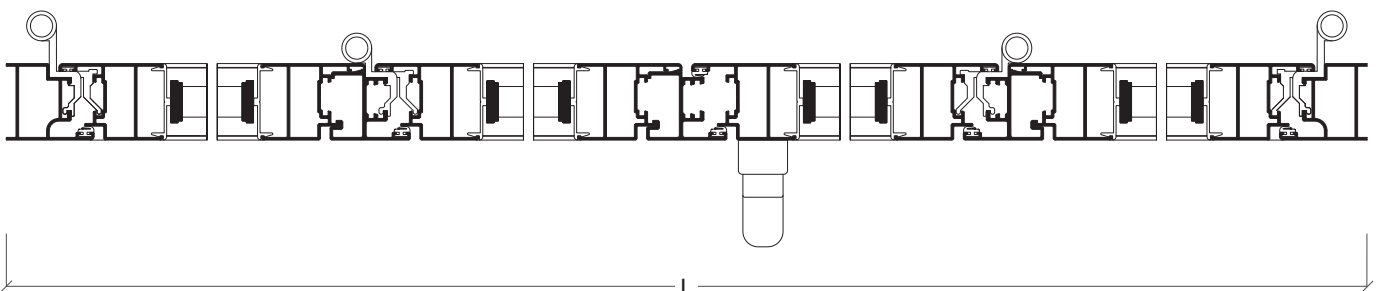

Porta 2 folhas abertura exterior

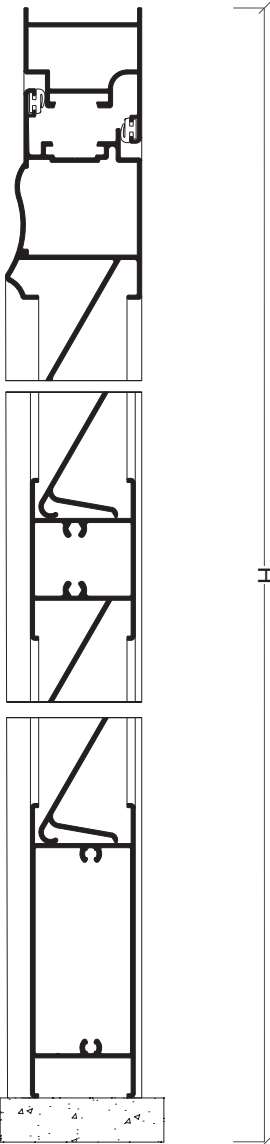
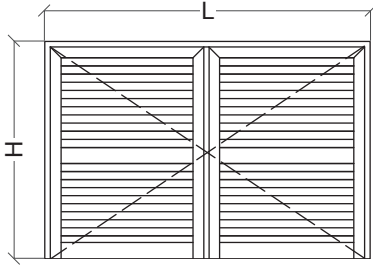

Perfis

| Desenho | Ref | Descrição | Corte | Quant | Medida |
|---------|-------|-----------------|-------|----------------|--------------|
| | BE-01 | Aro fixo | | 1 | L |
| | | | | 2 | H |
| | BE-24 | Aro móvel | | 2 | L/2-30 mm |
| | | | | 4 | H-33 mm |
| | BE-04 | Inversor | | 1 | H-156 mm |
| | BE-05 | Travessa 55 mm | | 2 | (L-146 mm)/2 |
| | BE-09 | Travessa 100 mm | | 2 | (L-146 mm)/2 |
| | Z-34 | Lâmina fixa | | Segundo altura | (L-146 mm)/2 |
| | AX-19 | Vareta | | 2 | Apro. H/2 mm |

Acessórios e Juntas

| Referência | Descrição | Quantidade |
|-------------|---------------------------|------------|
| --- | Dobradiça aro fixo | 8 |
| 31 02 70 01 | Esquadro janela | 2 |
| 31 02 70 02 | Esquadro porta | 4 |
| 30 94 01 38 | Cremona abertura exterior | 1 |
| 30 94 01 39 | Kit fixação cremona | 1 |
| 30 94 01 40 | Parafuso de ligação | 2 |
| 30 92 00 40 | Terminal de fecho | 2 |
| 31 02 60 04 | Jogo topos | 1 |
| 30 92 01 20 | Fecho 2ª folha | 1 |
| 30 96 00 22 | Esquadro alinhamento | 4 |
| --- | Contra-fecho aro fixo | 1 |
| 30 94 01 09 | Fixador de portada | 2 |
| 30 24 30 75 | Contra-fecho inferior | 1 |
| 31 02 60 50 | Junta de batente | 2L+6H |

Portalâminas

| |
|---------------|
| Hv = H-164 mm |
|---------------|

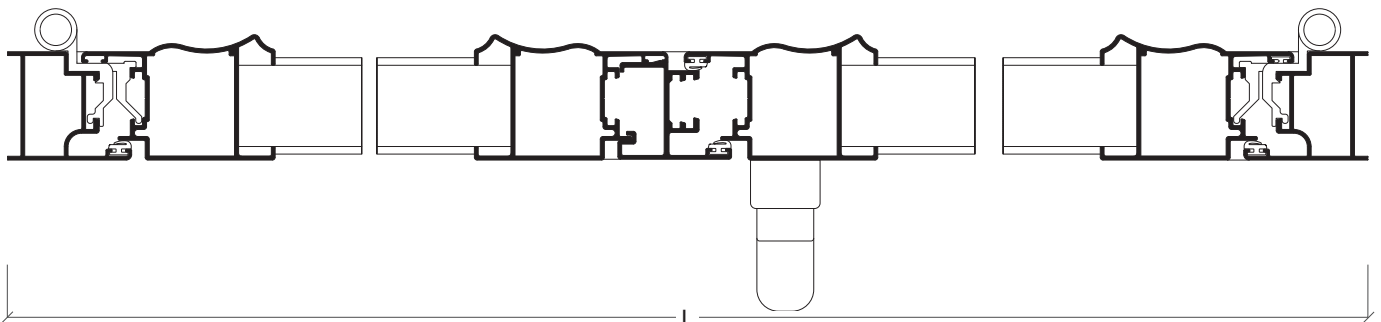

Porta 3 folhas abertura exterior

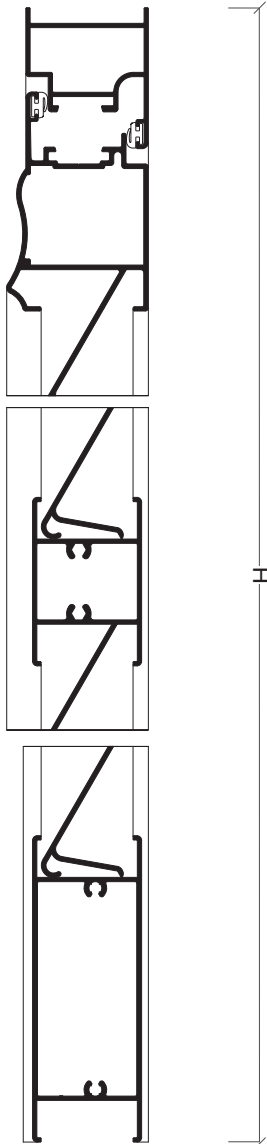
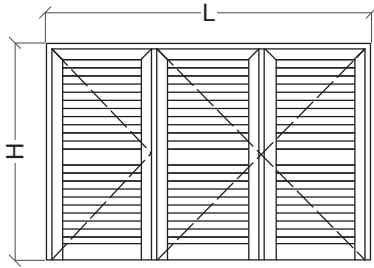

Perfis

| Desenho | Ref | Descrição | Corte | Quant | Medida |
|---------|-------|-----------------|-------|----------------|---------------------|
| | BE-01 | Aro fixo | | 1 | L |
| | | | | 2 | H |
| | BE-24 | Aro móvel | | 2 | Lat. = L/3 mm |
| | | | | 1 | Centr. = L/3-67 mm |
| | | | | 6 | H-33 mm |
| | BE-04 | Inversor | | 2 | H-56 mm |
| | BE-05 | Travessa 55 mm | | 2 | Lat. = L/3-116 mm |
| | | | | 1 | Centr. = L/3-183 mm |
| | BE-09 | Travessa 100 mm | | 2 | Lat. = L/3-116 mm |
| | | | | 1 | Centr. = L/3-183 mm |
| | Z-34 | Lâmina fixa | | Segundo altura | Lat. = L/3-116 mm |
| | | | | Segundo altura | Centr. = L/3-183 mm |
| | AX-19 | Vareta | | 2 | Apro. H/2 mm |

Acessórios e Juntas

| Referência | Descrição | Quantidade |
|-------------|-------------------------------|------------|
| --- | Dobradiça aro fixo | 8 |
| --- | Dobradiça de balanço aro fixo | 4 |
| 31 02 70 01 | Esquadro janela | 2 |
| 31 02 70 02 | Esquadro porta | 6 |
| 30 94 01 38 | Cremona abertura exterior | 1 |
| 30 94 01 39 | Kit fixação cremona | 1 |
| 30 94 01 40 | Parafuso de ligação | 2 |
| 30 92 00 40 | Terminal de fecho | 2 |
| 31 02 60 04 | Jogo topos | 2 |
| 30 92 01 20 | Fecho 2ª folha | 2 |
| 30 96 00 22 | Esquadro alinhamento | 6 |
| --- | Contra-fecho aro fixo | 2 |
| 30 94 01 09 | Fixador de portada | 1 |
| 30 94 01 10 | Fixador de portada duplo | 1 |
| 30 24 30 75 | Contra-fecho inferior | 2 |
| 31 02 60 50 | Junta de batente | 2L+6H |

Portalâminas

| |
|---------------|
| Hv = H-164 mm |
|---------------|

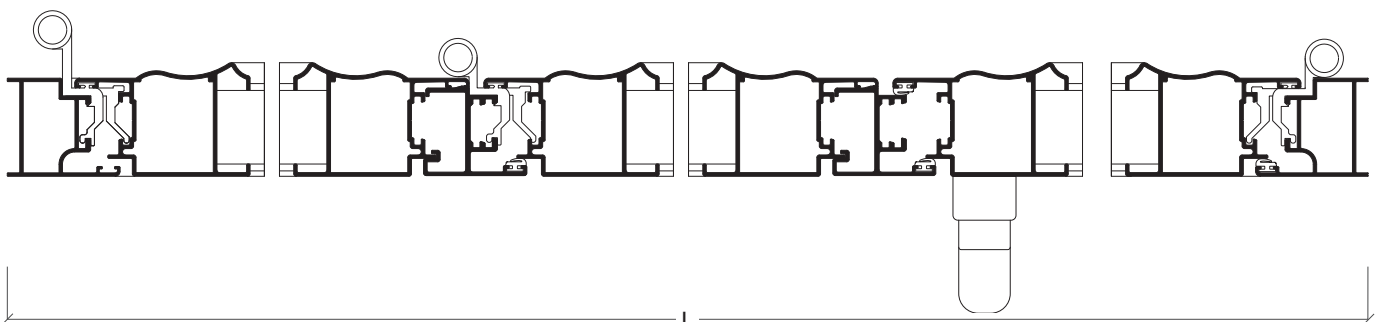

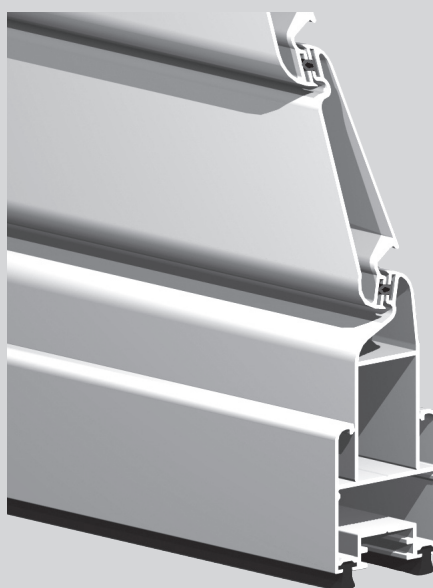

Sistema

XP

Sistema XP

Sistema de Portadas

Características do sistema

Sistema de portada que oferece a possibilidade de dois tipos de lâminas:

- Lâminas fixas
- Lâminas orientáveis

As lâminas orientáveis permitem uma total regulação através de mecanismos de rotação que permitem assim um controle da luminosidade de interior.

Este sistema não utiliza inversores graças à fisionomia da folha, utilizando apenas um pequeno perfil de batente.

Perfis de alumínio

As secções do aro e do móvel são de 40 e 47 mm respectivamente, com uma espessura média dos perfis de alumínio de 1.5 mm.

Dimensionamento e manobralidade

Possibilidades de abertura: exterior (1, 2, 3 e 4 folhas), harmónio e correr.

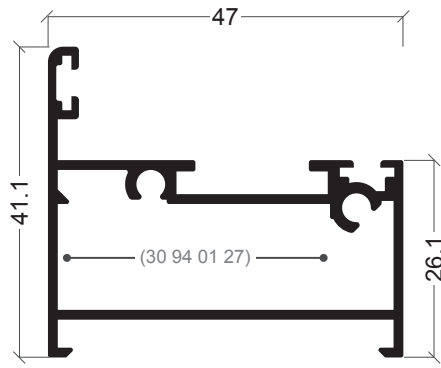

XP-03
Aro fixo

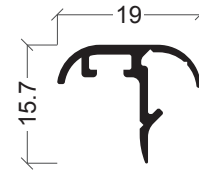

XP-04
Perfil de batente

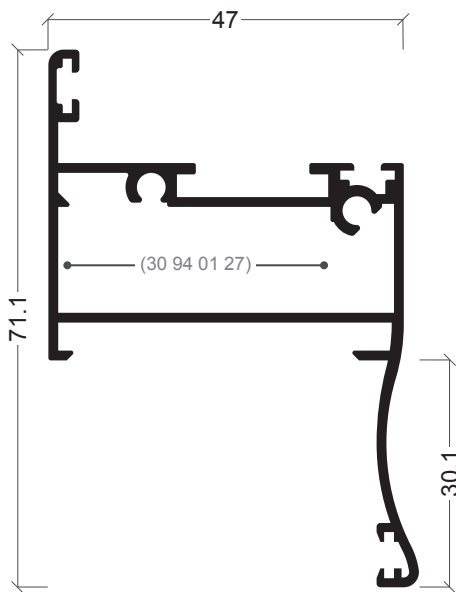

XP-09
Aro fixo com remate

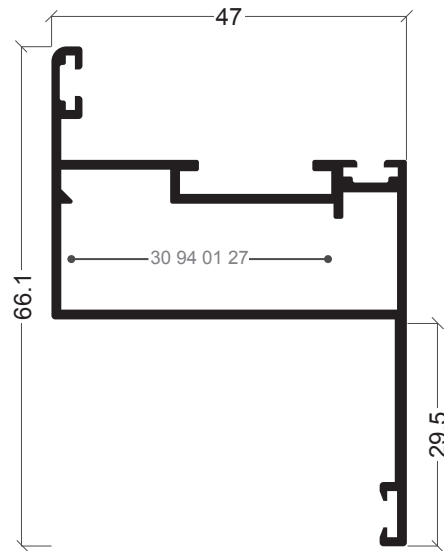

XP-26
Aro fixo com remate

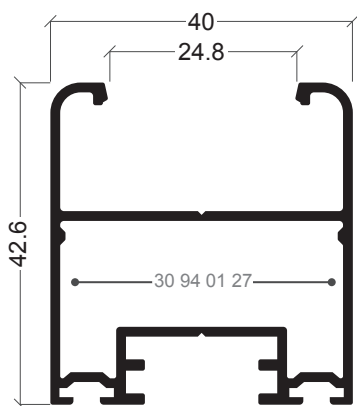

XP-05
Aro móvel

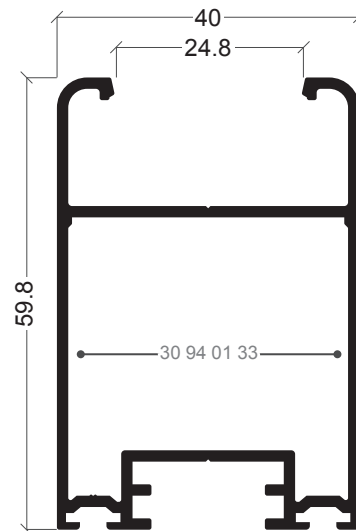

XP-18
Aro móvel

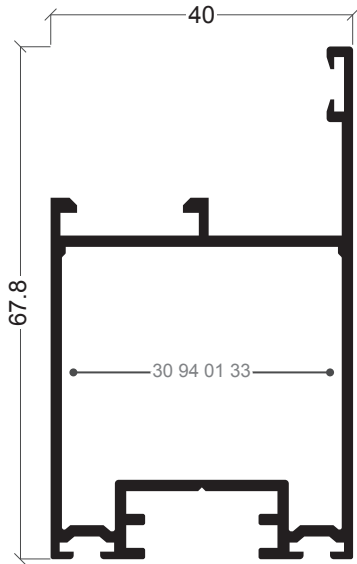

XP-22
Aro móvel com bite

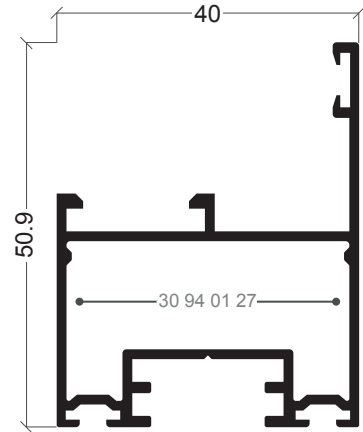

XP-11
Aro móvel com bite

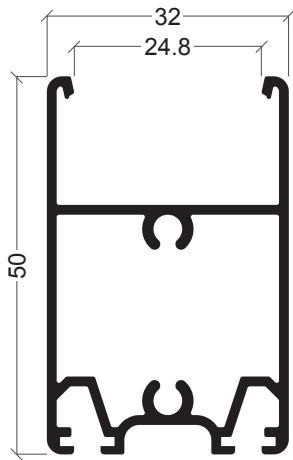

XP-10
Almofada 50 mm

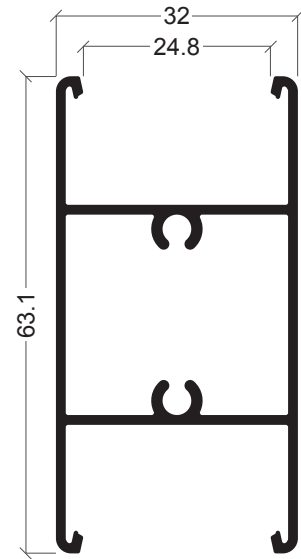

XP-25
Travessa 63 mm

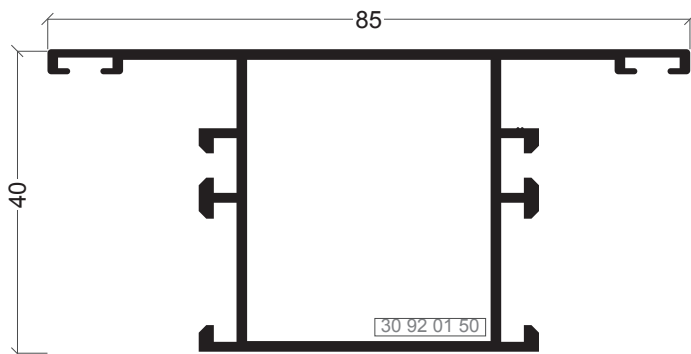

AZ-09
Travessa

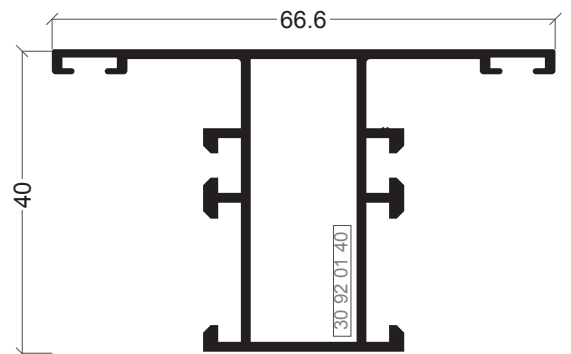

AZ-01
Travessa

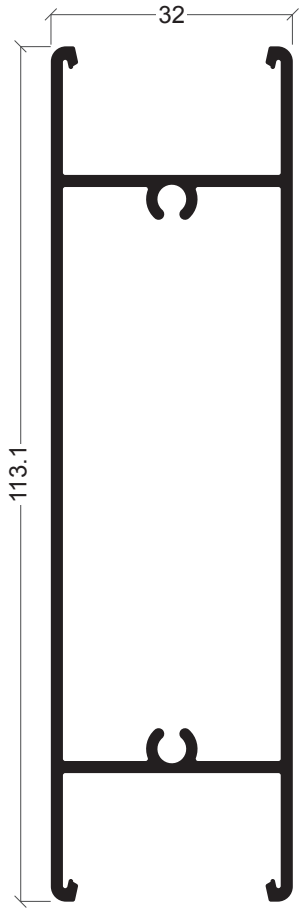

XP-27
Travessa 113 mm

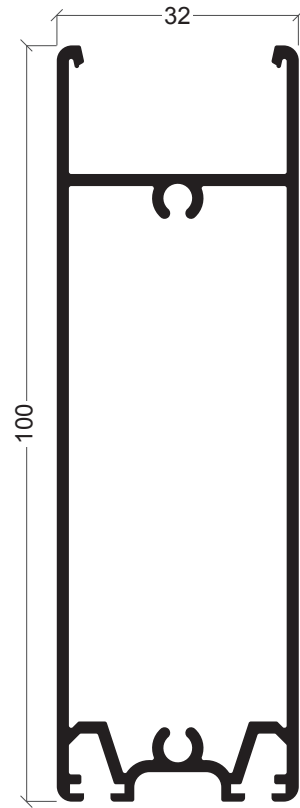

XP-16
Almofada 100 mm

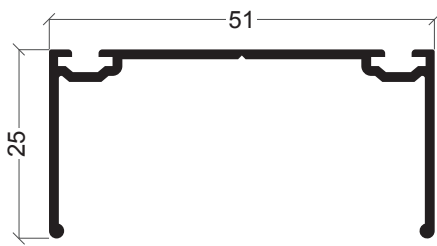

XP-20
Distanciador aro fixo de correr

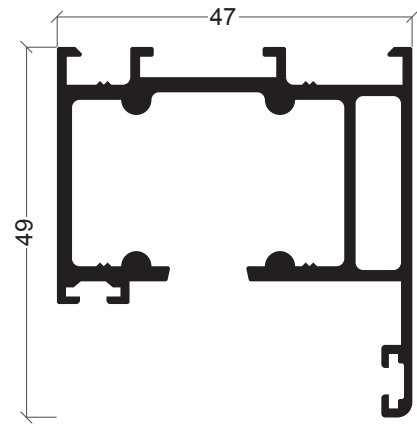

XP-21
Aro fixo de correr

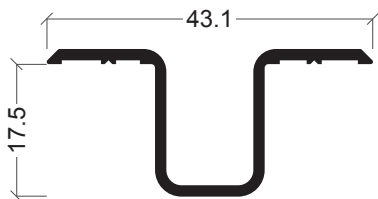

XP-23
Guia embutir de correr

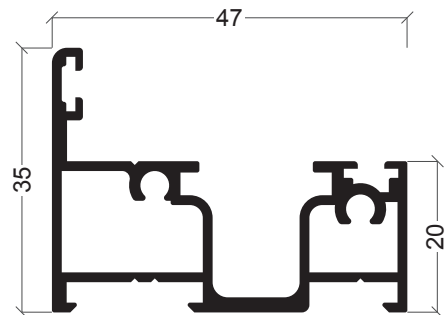

XP-24
Aro fixo guia de correr

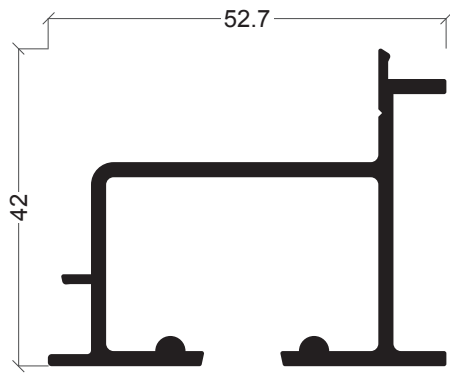

XP-07
Guia superior de correr

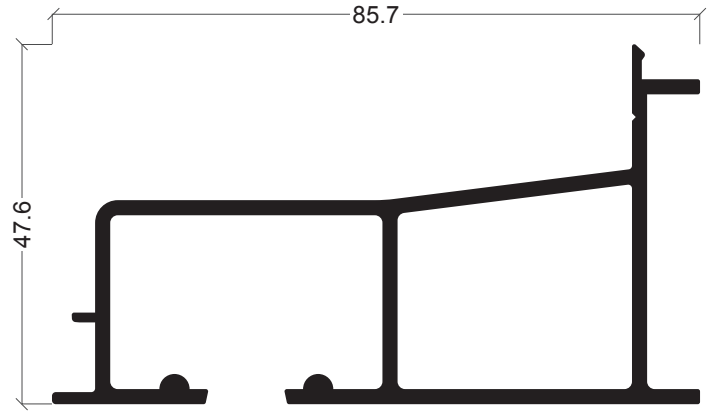

XP-13
Guia superior de correr

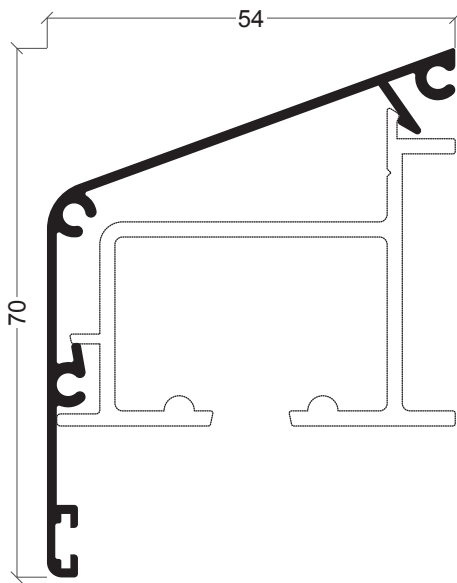

XP-06
Tampa guia superior de correr

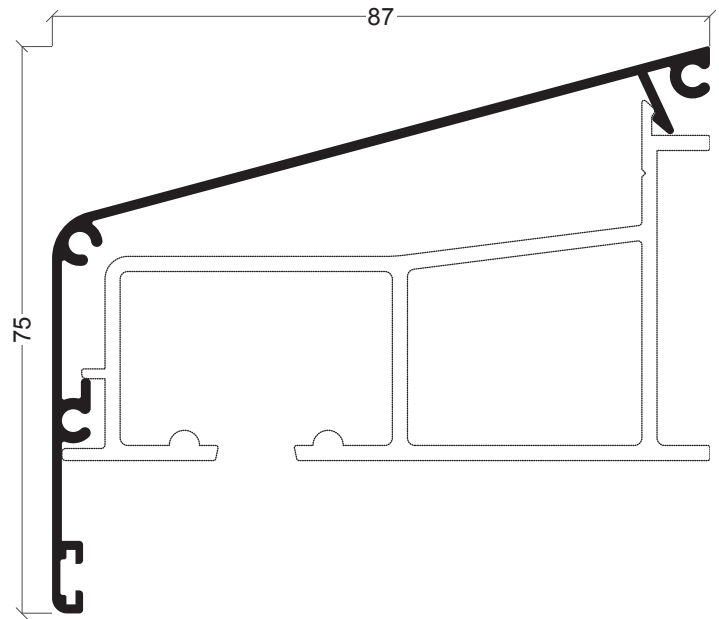

XP-12
Tampa guia superior de correr longa

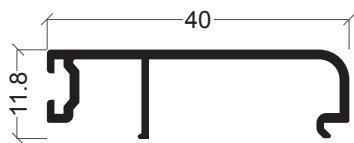

XP-08
Tampa lateral de correr

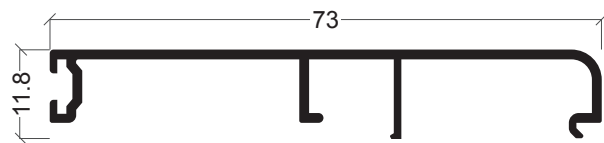

XP-14
Tampa lateral de correr larga

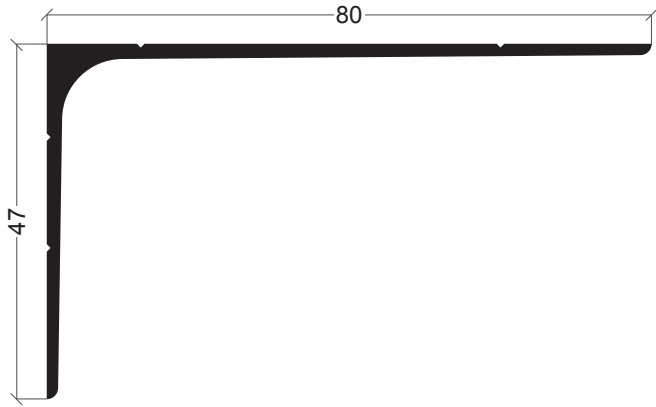

XP-15
Guia inferior de correr

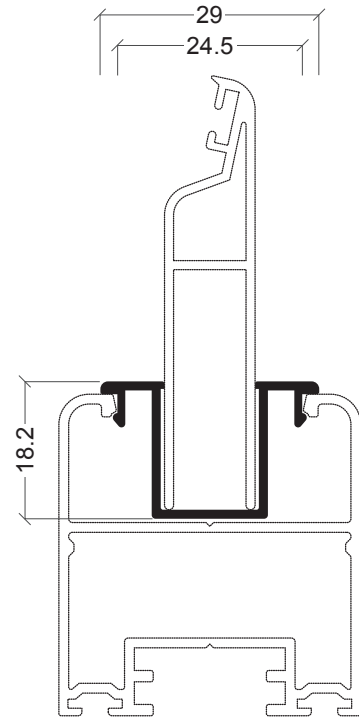

XP-19
Redutor para Z/54

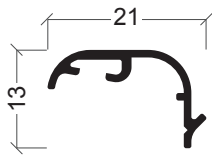

XP-17
Perfil batente de correr



AX-19
Vareta

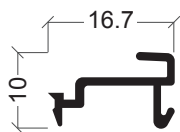

AX-33
Mola Bite

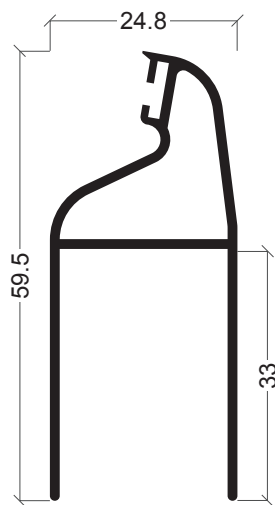

XP-01
Meia lâmina 33 mm

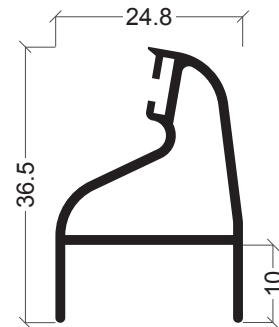

XP-02
Meia lâmina 10 mm

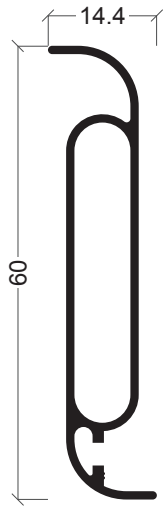

Z-52
Lâmina móvel

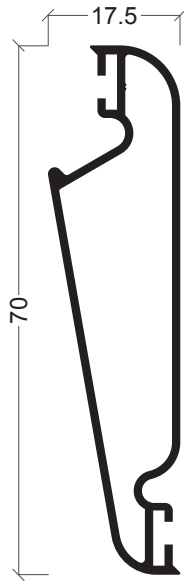

Z-53
Lâmina móvel

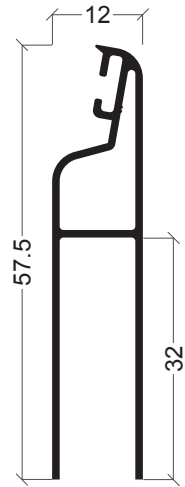

Z-54
Meia lâmina 32 mm

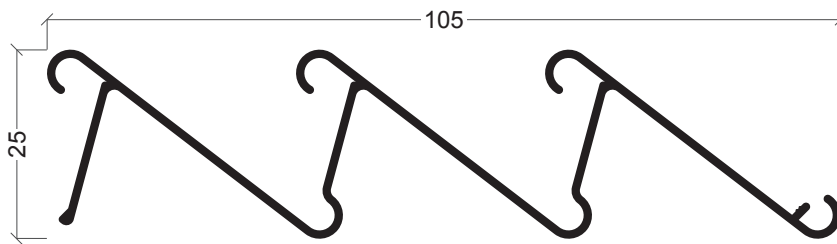

Z-20
Meia lâmina

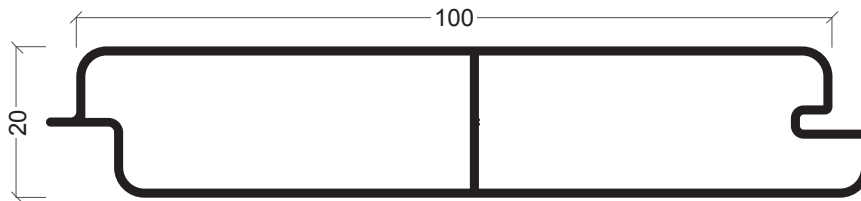

W-25
Lâmina de encaixe 100 x 20

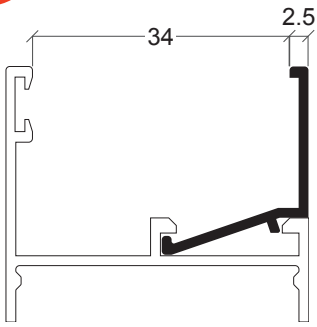

AX-69

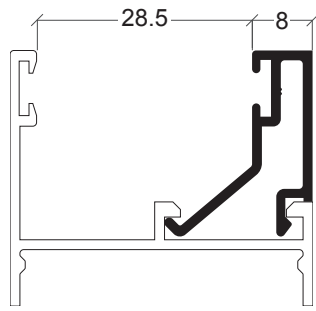

AX-74

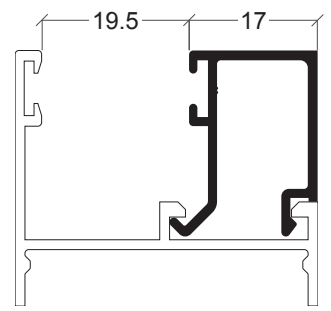

AX-46

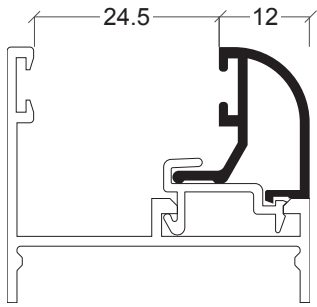

AX-37

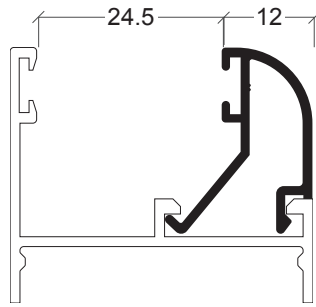

AZ-8

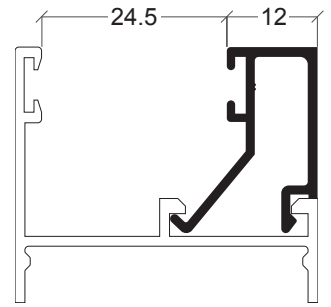

AX-36

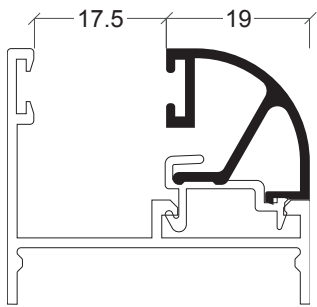

AX-30

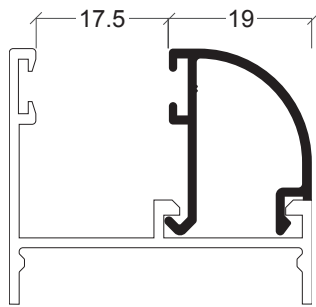

AZ-7

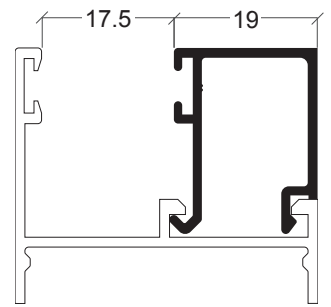

AX-35

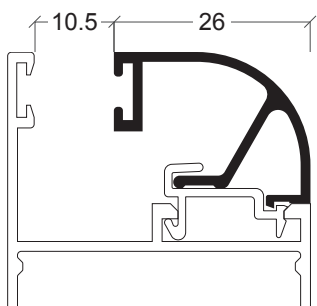

AX-29

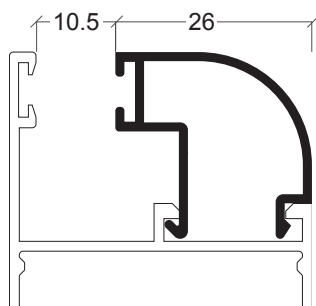

AZ-6

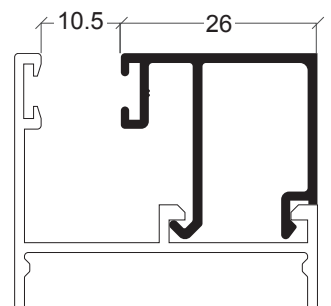

AX-31

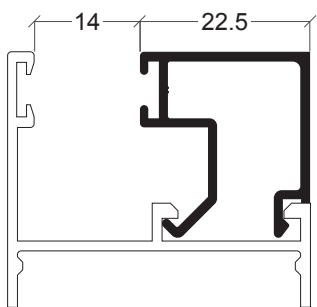

AX-78

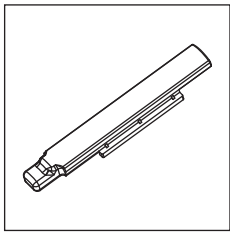
30 92 00 41

Terminal superior

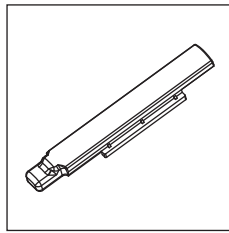
30 92 00 42

Terminal inferior

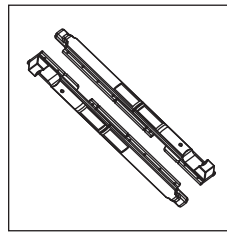
30 92 01 20

Fecho 2ª folha

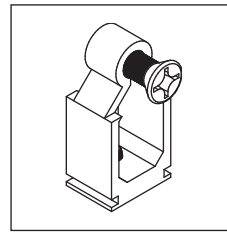
30 92 01 40

União topos janela

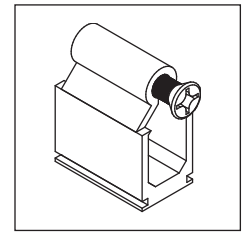
30 92 01 50

União topos porta

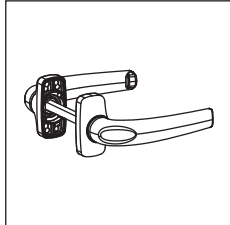
30 92 05 60

Puxador duplo

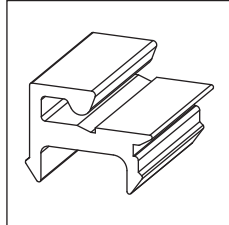
30 94 01 01

Mola bite plástica

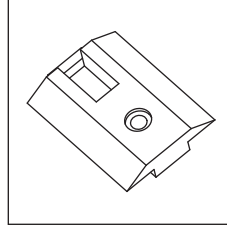

30 94 01 02

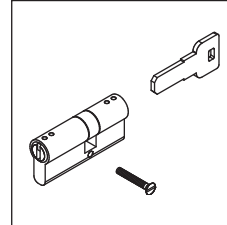
Complemento de fecho

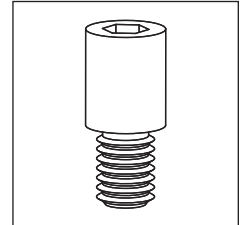

30 94 01 03

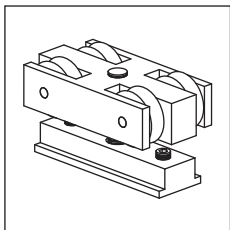
Canhão 30x30

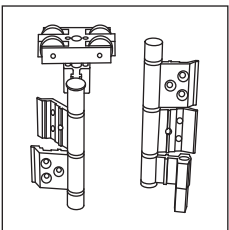

30 94 01 04

 Jogo parafusos
distanciadores

30 94 01 05

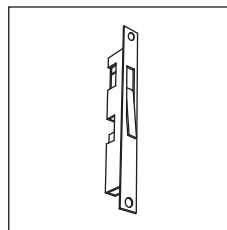
Rolamentos

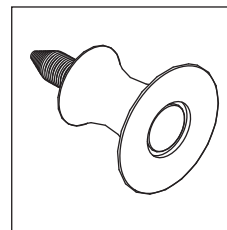

30 94 01 06/14

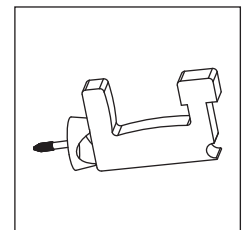
 Rolamento e dobradiça
harmónio (branco/preto)

30 94 01 07/15

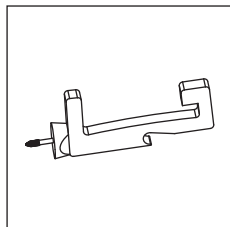
 Fecho de embutir
(branco/preto)

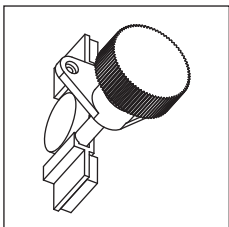
30 94 01 08/16

 Aplicador fixador (branco/
preto)

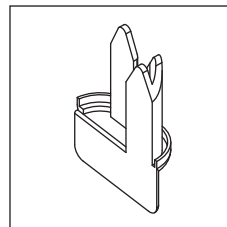
30 94 01 09/17

 Fixador de portada 2
folhas (branco/preto)

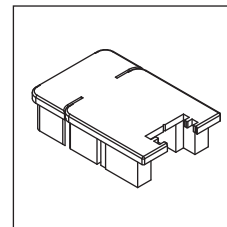
30 94 01 10/18

 Fixador portada 4 folhas
(branco/preto)

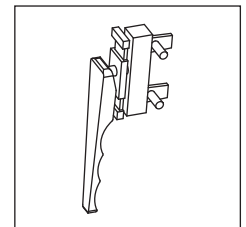
30 94 01 11/19

 Comando lâminas
orientáveis (branco/preto)

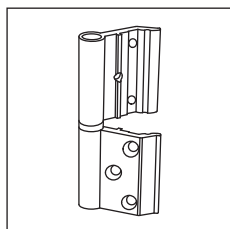
30 94 01 12/20

 Jogo topos perfil batente
(branco/preto)

30 94 01 13/21

 Tampa aro móvel
(branco/preto)

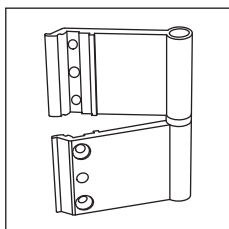
30 94 01 23/29 - 30 94 02 23/29

 Cremone 4ª folha direito (branco/
preto) - esquerdo (branco/preto)

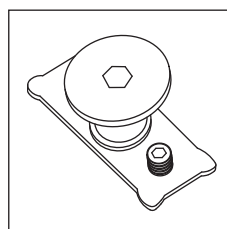
30 94 01 24/30

Dobradiça (branco/preto)

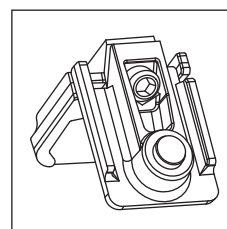

30 94 01 25/31

 Dobradiça 4ª folha
(branco/preto)

30 94 01 26

Distanciador aro

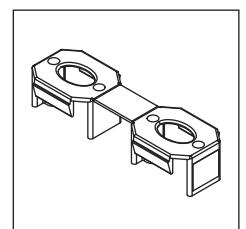
30 94 01 27

Esquadro janela

30 94 01 32

Distanciador travessa

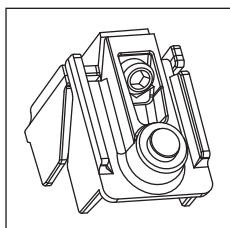
30 94 01 33

Esquadro porta

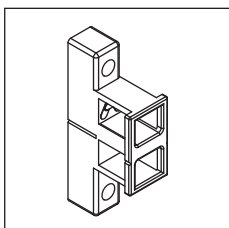

30 94 01 34

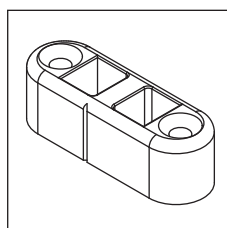
Fecho superior correr

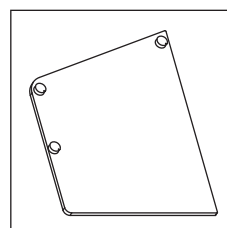

30 94 01 35

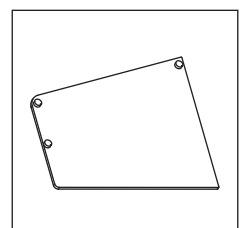
Fecho inferior correr

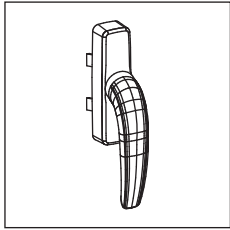

30 94 01 36

 Tampa lateral correr
54 mm

30 94 01 37

 Tampa lateral correr
87 mm

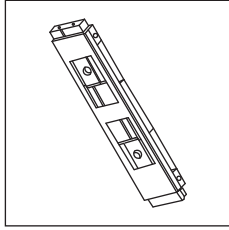
30 94 01 38

Cremone abertura exterior

30 94 01 39

Kit fixação cremone abertura exterior

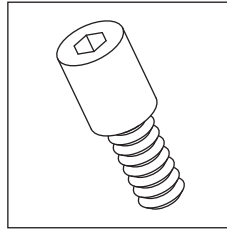
30 94 01 40

Distanciador abertura exterior 14 mm

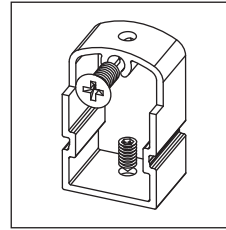
30 94 01 42

Topo travessa XP-10

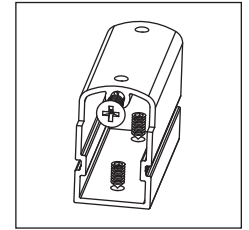
30 94 01 43



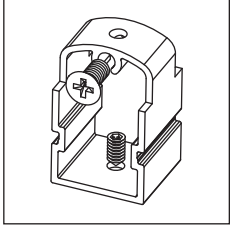

Topo travessa XP-16

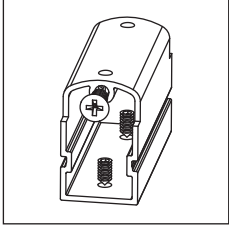
30 94 01 44

União topos janela

30 94 01 45

Topo travessa XP-27

| Referência | Desenho | Descrição |
|-------------|-------------------------------------------------------------------------------------|-------------------------|
| 30 93 01 40 |  | Junta lâminas |
| 30 94 01 46 |  | Junta interior/exterior |
| 30 95 00 10 |  | Pelúcia 7x9 mm |
| 30 95 00 30 |  | Pelúcia 7x7 mm |

Janela 1 folha abertura exterior

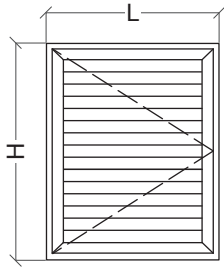

Perfis

| Desenho | Ref | Descrição | Corte | Quant | Medida |
|---------|-------|---------------------|-------|----------------|--------------|
| | XP-03 | Aro fixo | | 1 | L |
| | | | | 2 | H |
| | XP-05 | Aro móvel de janela | | 2 | L-64 mm |
| | | | | 2 | H-37 mm |
| | XP-01 | Meia lâmina | | 2 | L-173 mm |
| | Z-53 | Lâmina | | Segundo altura | L-163 mm |
| | AX-19 | Vareta | | 2 | Apro. H/2 mm |

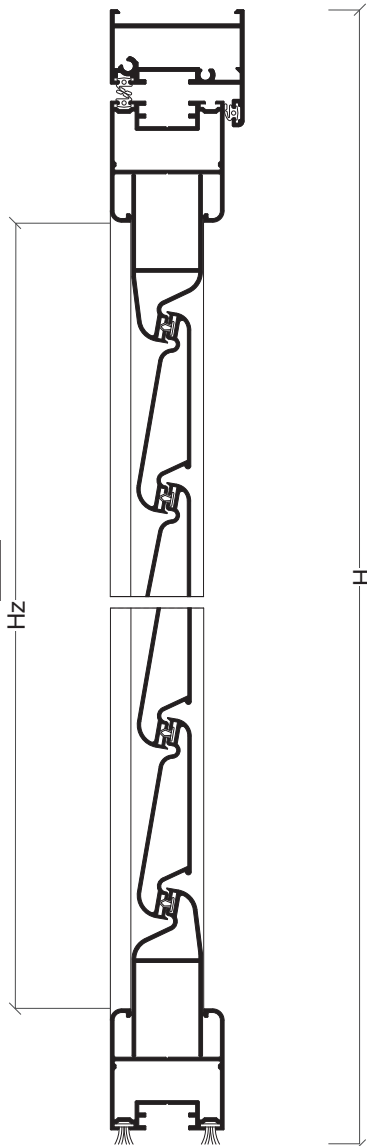

Acessórios e Juntas

| Referência | Descrição | Quantidade |
|-------------|--------------------------------------|-----------------|
| 30 94 01 02 | Complemento fecho de portada | 2 |
| 30 94 01 09 | Fixador de portada | 1 |
| 30 94 01 24 | Dobradiça branca | 2 |
| 30 94 01 27 | Esquadro de janela | 6 |
| 30 92 00 41 | Terminal de fecho | 2 |
| 30 94 01 38 | Cremona abertura exterior | 1 |
| 30 94 01 39 | Kit fixação cremona | 1 |
| 30 94 01 40 | Distanciador 14 mm abertura exterior | 2 |
| --- | Jogo portalâminas (segundo altura) | 1 |
| 30 93 01 40 | Vedante lâminas | Nº lâminas + 1L |
| 30 94 01 46 | Junta interior/exterior | 3L+6H |
| 30 95 00 30 | Pelúcia 7x7 mm | 2L |

Portalâminas

| |
|---------------|
| Hz = H-122 mm |
|---------------|

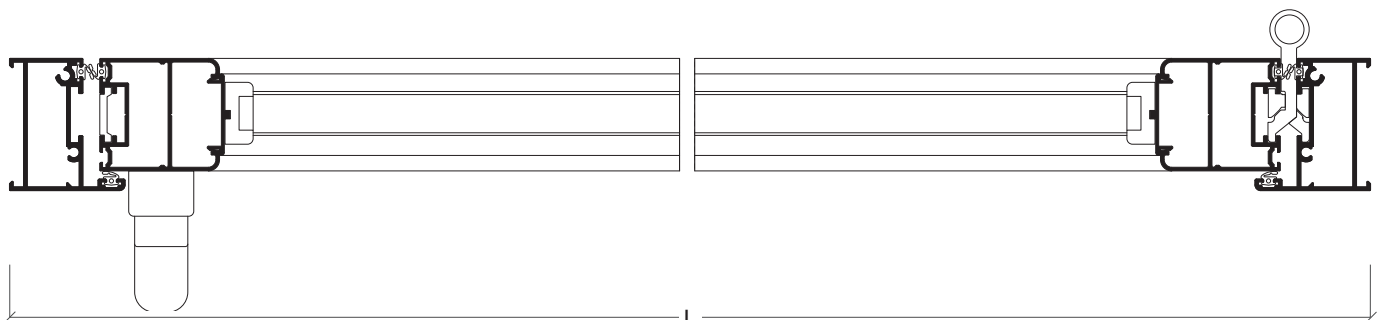

Janela 1 folha abertura exterior - lâminas fixas

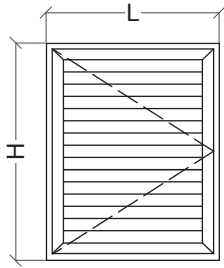

Perfis

| Desenho | Ref | Descrição | Corte | Quant | Medida |
|---------|-------|---------------------|-------|----------------|--------------|
| | XP-03 | Aro fixo | | 1 | L |
| | | | | 2 | H |
| | XP-05 | Aro móvel de janela | | 2 | L-64 mm |
| | | | | 2 | H-37 mm |
| | W-25 | Lâmina | | Segundo altura | H-93 mm |
| | AX-19 | Vareta | | 2 | Apro. H/2 mm |

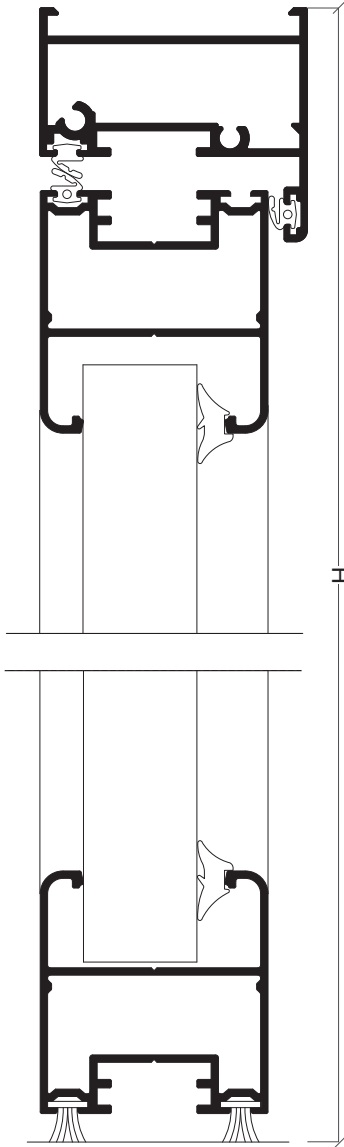

Acessórios e Juntas

| Referência | Descrição | Quantidade |
|-------------|--------------------------------------|------------|
| 30 94 01 02 | Complemento fecho de portada | 2 |
| 30 94 01 09 | Fixador de portada | 1 |
| 30 94 01 24 | Dobradiça branca | 2 |
| 30 94 01 27 | Esquadro de janela | 6 |
| 30 92 00 40 | Terminal de fecho | 2 |
| 30 94 01 38 | Cremone abertura exterior | 1 |
| 30 94 01 39 | Kit fixação cremone | 1 |
| 30 94 01 40 | Distanciador 14 mm abertura exterior | 2 |
| 30 94 01 46 | Junta interior/exterior | 3L+6H |
| 30 95 00 30 | Pelúcia 7x7 mm | 2L |
| 30 93 00 65 | Junta de cunha | 2L+2H |

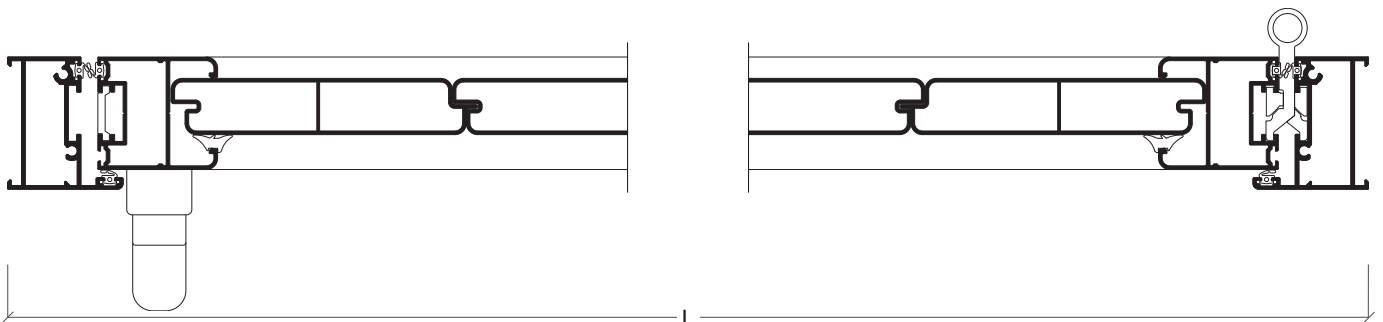

Janela 2 folhas abertura exterior

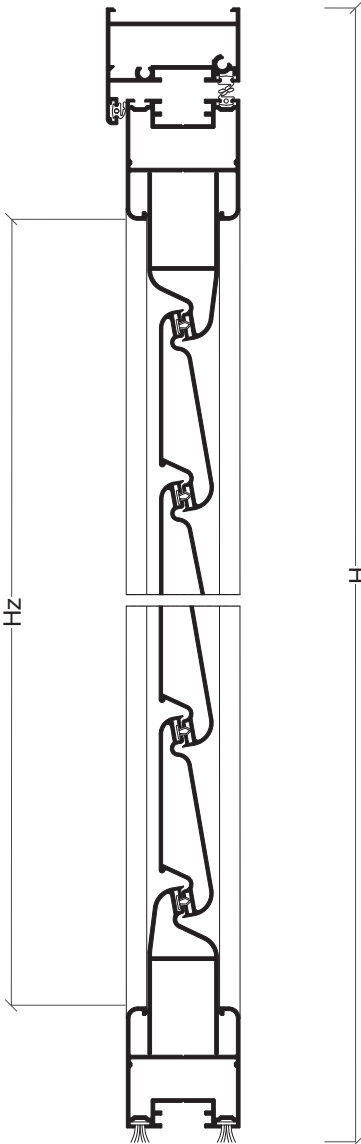
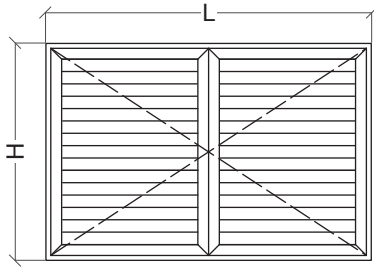

Perfis

| Desenho | Ref | Descrição | Corte | Quant | Medida |
|---------|-------|---------------------|-------|----------------|--------------|
| | XP-03 | Aro fixo | | 1 | L |
| | | | | 2 | H |
| | XP-05 | Aro móvel de janela | | 4 | L/2-37 mm |
| | | | | 4 | H-37 mm |
| | XP-01 | Meia lâmina | | 4 | L/2-144 mm |
| | Z-53 | Lâmina | | Segundo altura | L/2-134 mm |
| | XP-04 | Perfil de batente | | 2 | H-37 mm |
| | AX-19 | Vareta | | 2 | Apro. H/2 mm |

Acessórios e Juntas

| Referência | Descrição | Quantidade |
|-------------|--------------------------------------|--------------------|
| 30 92 00 41 | Terminal de fecho | 2 |
| 30 94 01 02 | Complemento fecho de portada | 2 |
| 30 92 01 20 | Fecho 2ª folha | 2 |
| 30 94 01 09 | Fixador de portada | 2 |
| 30 94 01 12 | Jogo topos para perfil batente | 2 |
| 30 94 01 24 | Dobradiça | 4 |
| 30 94 01 27 | Esquadro de janela | 10 |
| 30 94 01 38 | Cremona abertura exterior | 1 |
| 30 94 01 39 | Kit fixação cremona | 1 |
| 30 94 01 40 | Distanciador 14 mm abertura exterior | 2 |
| --- | Jogo portalâminas (segundo altura) | 1 |
| 30 93 01 40 | Vedante lâminas | Nº lâminas + 1 L/2 |
| 30 94 01 46 | Junta interior/exterior | 2L+2L/2+8H |
| 30 95 00 30 | Pelúcia 7x7 mm | 4L/2 |

Portalâminas

Hz = H-122 mm

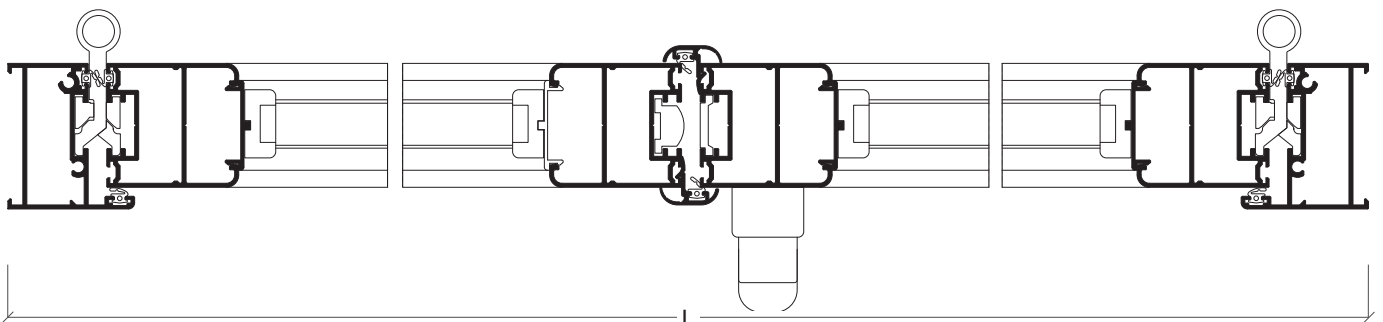

Janela 3 folhas abertura exterior

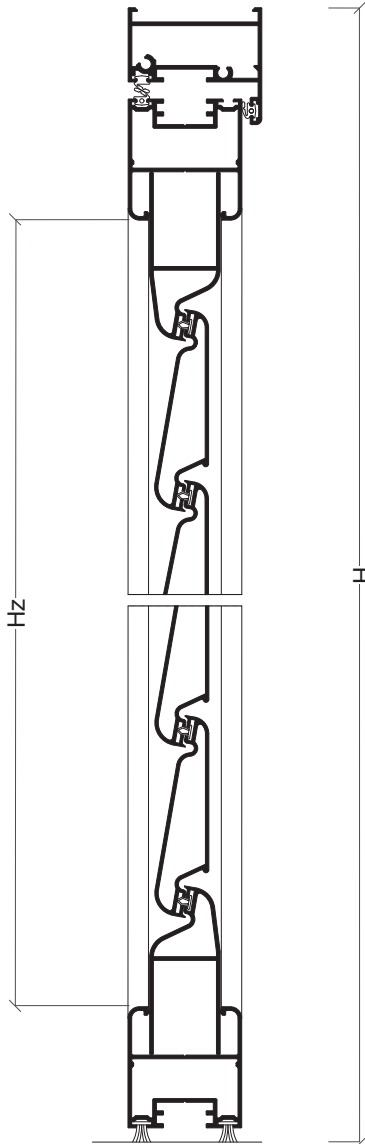
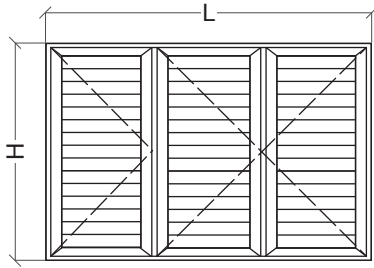

Perfis

| Desenho | Ref | Descrição | Corte | Quant | Medida |
|---------|-------|---------------------|-------|----------------|-------------------|
| | XP-03 | Aro fixo | | 1 | L |
| | | | | 2 | H |
| | XP-05 | Aro móvel de janela | | 4 | Lat. = L/2-37 mm |
| | | | | 2 | Cen. = L/3-42 mm |
| | | | | 6 | H-37 mm |
| | XP-01 | Meia lâmina | | 4 | Lat. = L/3-126 mm |
| | | | | 2 | Cen. = L/3-151 mm |
| | Z-53 | Lâmina | | Segundo altura | Lat. = L/3-116 mm |
| | | | | Segundo altura | Cen. = L/3-141 mm |
| | XP-04 | Perfil de batente | | 2 | H-37 mm |
| | AX-19 | Vareta | | 2 | Apro. H/2 mm |

Acessórios e Juntas

| Referência | Descrição | Quantidade |
|-------------|------------------------------------------|--------------------|
| 30 92 00 41 | Terminal de fecho | 2 |
| 30 94 01 02 | Complemento fecho de portada | 4 |
| 30 92 01 20 | Fecho 2ª folha | 4 |
| 30 94 01 09 | Fixador de portada (opcional) | 1 |
| 30 94 01 10 | Fixador de portada 3/4 folhas (opcional) | 1 |
| 30 94 01 12 | Jogo topos para perfil batente | 3 |
| 30 94 01 24 | Dobradiça | 4 |
| 30 94 01 25 | Dobradiça 3ª/4ª folha | 2 |
| 30 94 01 27 | Esquadro de janela | 14 |
| 30 94 01 38 | Cremona abertura exterior | 1 |
| 30 94 01 39 | Kit fixação cremone | 1 |
| 30 94 01 40 | Distanciador 14 mm abertura exterior | 2 |
| --- | Jogo portalâminas (segundo altura) | 3 |
| 30 93 01 40 | Vedante lâminas | Nº lâminas + 1 L/3 |
| 30 94 01 46 | Junta interior/exterior | 2L+3L/3+11H |
| 30 95 00 30 | Pelúcia 7x7 mm | 6L/2 |

15

Portalâminas

| |
|---------------|
| Hz = H-122 mm |
|---------------|

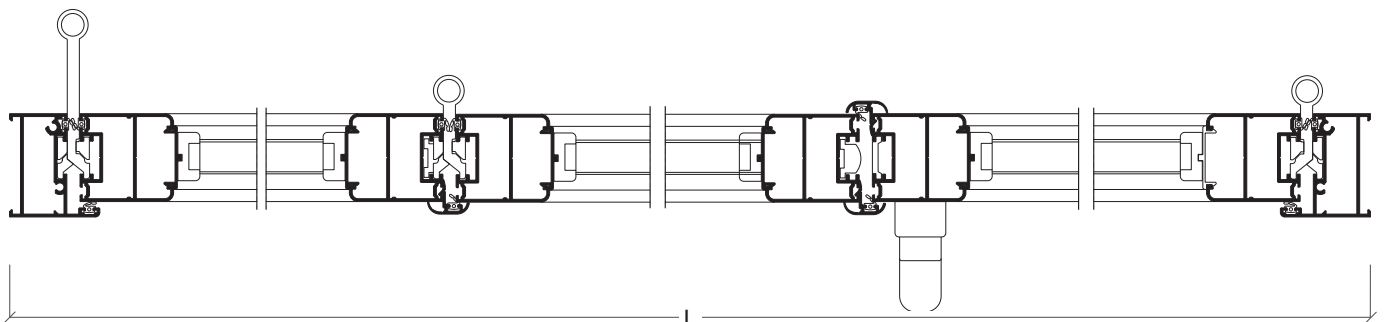

Janela 4 folhas abertura exterior

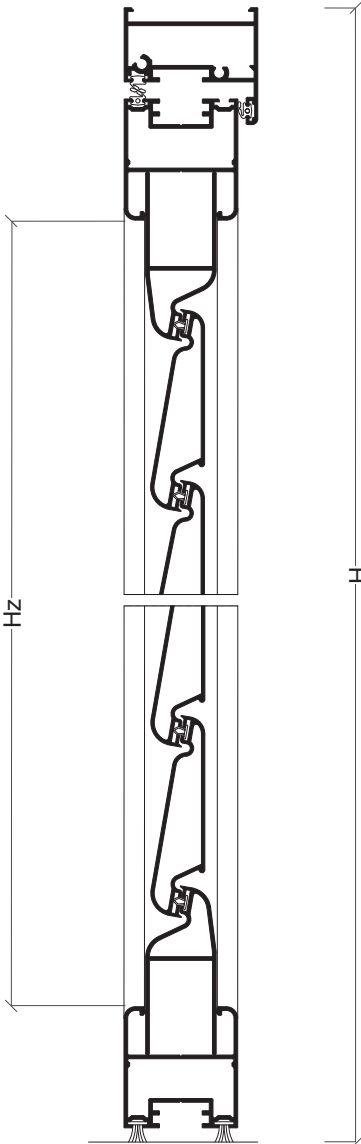
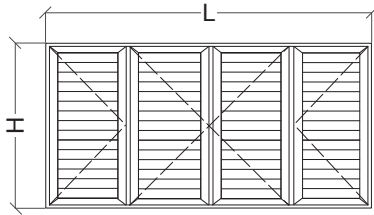

Perfis

| Desenho | Ref | Descrição | Corte | Quant | Medida |
|---------|-------|---------------------|-------|----------------|-------------------|
| | XP-03 | Aro fixo | | 1 | L |
| | | | | 2 | H |
| | XP-05 | Aro móvel de janela | | 4 | Lat. = L/4-8 mm |
| | | | | 4 | Cen. = L/4-33 mm |
| | | | | 8 | H-37 mm |
| | XP-01 | Meia lâmina | | 4 | Lat. = L/4-117 mm |
| | | | | 4 | Cen. = L/4-132 mm |
| | Z-53 | Lâmina | | Segundo altura | Lat. = L/4-107 mm |
| | | | | Segundo altura | Cen. = L/4-132 mm |
| | XP-04 | Perfil de batente | | 4 | H-37 mm |
| | AX-19 | Vareta | | 2 | Apro. H/2 mm |

Acessórios e Juntas

| Referência | Descrição | Quantidade |
|-------------|------------------------------------------|--------------------|
| 30 92 00 41 | Terminal de fecho | 2 |
| 30 94 01 02 | Complemento fecho de portada | 6 |
| 30 92 01 20 | Fecho 2ª folha | 6 |
| 30 94 01 09 | Fixador de portada (opcional) | 2 |
| 30 94 01 10 | Fixador de portada 3/4 folhas (opcional) | 2 |
| 30 94 01 12 | Jogo topos para perfil batente | 4 |
| 30 94 01 24 | Dobradiça | 4 |
| 30 94 01 25 | Dobradiça 3ª/4ª folha | 4 |
| 30 94 01 27 | Esquadro de janela | 18 |
| 30 94 01 38 | Cremone abertura exterior | 1 |
| 30 94 01 39 | Kit fixação cremone | 1 |
| 30 94 01 40 | Distanciador 14 mm abertura exterior | 2 |
| --- | Jogo portalâminas (segundo altura) | 4 |
| 30 93 01 40 | Vedante lâminas | Nº lâminas + 1 L/4 |
| 30 94 01 46 | Junta interior/exterior | 2L+4L/4+14H |
| 30 95 00 30 | Pelúcia 7x7 mm | 8L/4 |

Portalâminas

| |
|---------------|
| Hz = H-122 mm |
|---------------|

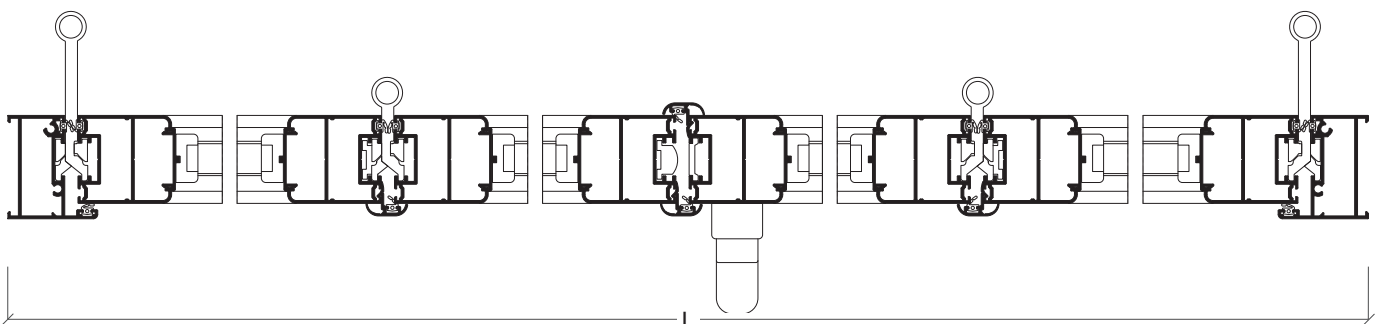

Porta 2 folhas abertura exterior

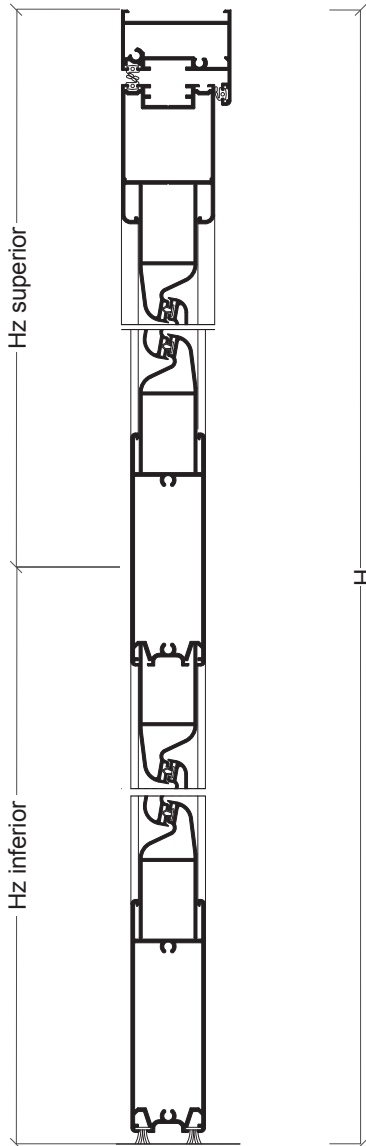
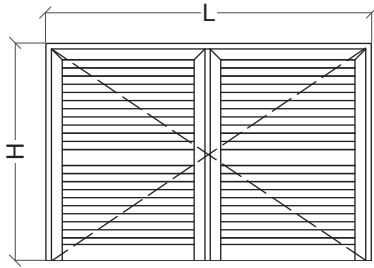

Perfis

| Desenho | Ref | Descrição | Corte | Quant | Medida |
|---------|-------|--------------------|-------|----------------|--------------|
| | XP-03 | Aro fixo | | 1 | L |
| | | | | 2 | H |
| | XP-18 | Aro móvel de porta | | 2 | L/2-35 mm |
| | | | | 4 | H-37 mm |
| | XP-16 | Almofada 100 mm | | 4 | L/2-154 mm |
| | XP-01 | Meia lâmina | | 8 | L/2-178 mm |
| | Z-53 | Lâmina | | Segundo altura | L/2-168 mm |
| | XP-04 | Perfil de batente | | 2 | H-37 mm |
| | AX-19 | Vareta | | 2 | Apro. H/2 mm |

Acessórios e Juntas

| Referência | Descrição | Quantidade |
|-------------|-----------------------------------------|--------------------|
| 30 94 01 38 | Cremona abertura exterior | 1 |
| 30 94 01 02 | Complemento fecho de portada | 2 |
| 30 94 01 39 | Kit fixação cremona | 1 |
| 30 94 01 12 | Jogo topos para perfil batente | 2 |
| 30 94 01 13 | Tampa da folha | 4 |
| 30 94 01 24 | Dobradiça | 8 |
| 30 94 01 27 | Esquadro de janela | 2 |
| 30 94 01 32 | Distanciador de travessa | 8 |
| 30 94 01 33 | Esquadro porta | 4 |
| 30 92 02 40 | Fecho 2ª folha | 6 |
| 30 94 01 40 | Distanciador 14 mm abertura exterior | 2 |
| 30 92 05 60 | Puxador duplo | 1 |
| --- | Jogo portalâminas (segundo Hz superior) | 2 |
| --- | Jogo portalâminas (segundo Hv inferior) | 2 |
| 30 93 01 40 | Vedante lâminas | Nº lâminas + 2 L/2 |
| 30 94 01 46 | Junta interior/exterior | 2L+2L/2+8H |
| 30 95 00 30 | Pelúcia 7x7 mm | 4L/2 |

Portalâminas

| |
|-------------------------|
| Hz superior = H1-148 mm |
| Hv inferior = H2-161 mm |

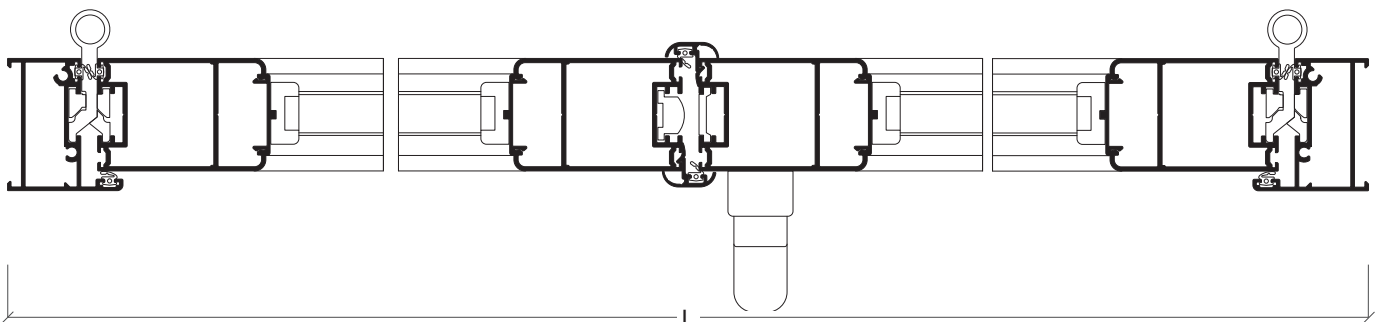

Porta 3 folhas harmónio abertura exterior

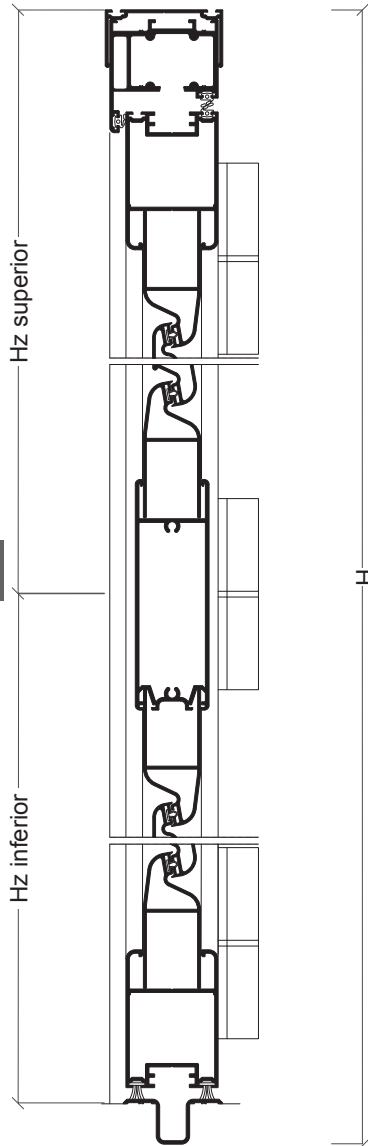
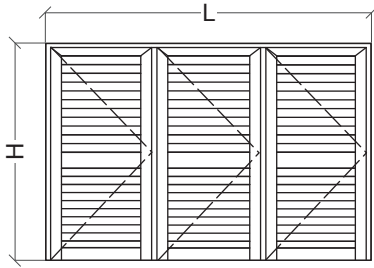

Perfis

| Desenho | Ref | Descrição | Corte | Quant | Medida |
|---------|-------|----------------------|-------|----------------|------------|
| | XP-20 | Distanciador de aro | | 1 | L |
| | XP-21 | Aro fixo para carril | | 1 | L |
| | XP-03 | Aro fixo | | 2 | H-31 mm |
| | XP-18 | Aro móvel de porta | | 6 | L/3-25 mm |
| | | | | 6 | H-47 mm |
| | XP-16 | Almofada 100 mm | | 3 | L/3-145 mm |
| | XP-01 | Meia lâmina | | 12 | L/3-168 mm |
| | Z-53 | Lâmina | | Segundo altura | L/3-158 mm |
| | XP-23 | Guia de embutir | | 1 | L |
| | AX-19 | Vareta | | 2 | Apro. H |

Dimensões máximas: 800x2500 mm por folha
Peso máximo: 40 Kg por folha

Acessórios e Juntas

| Referência | Descrição | Quantidade |
|-------------|------------------------------------------|--------------------|
| 30 94 01 04 | Jogo parafusos distanciadores | 2 |
| 30 94 01 07 | Fecho de embutir portada | 2 |
| 30 94 01 08 | Aplique fixador | 2 |
| 30 94 01 06 | Rolamentos/dobradiças harmónio | 1 |
| 30 94 01 23 | Cremona 4 folhas (opcional a A) | 2 |
| 30 94 01 24 | Dobradiça | 8 |
| 30 94 01 26 | Distanciador de pavimento | 4 |
| 30 94 01 32 | Distanciador chão | 8 |
| 30 94 01 33 | Esquadro porta | 12 |
| 30 92 00 41 | Terminal fecho | 2 |
| 30 92 00 42 | Terminal fecho inferior | 2 |
| --- | Jogo portalâminas (segundo Hz superior) | 3 |
| --- | Jogo portalâminas (segundo Hz inferior) | 3 |
| 30 93 01 40 | Vedante lâminas | Nº lâminas + 2 L/3 |
| 30 94 01 46 | Junta interior/exterior | 2L+3L/3+14H |
| 30 95 00 30 | Pelúcia 7x7 mm | 6L/3 |

Portalâminas

| |
|-------------------------|
| Hz superior = H1-156 mm |
| Hz inferior = H2-123 mm |

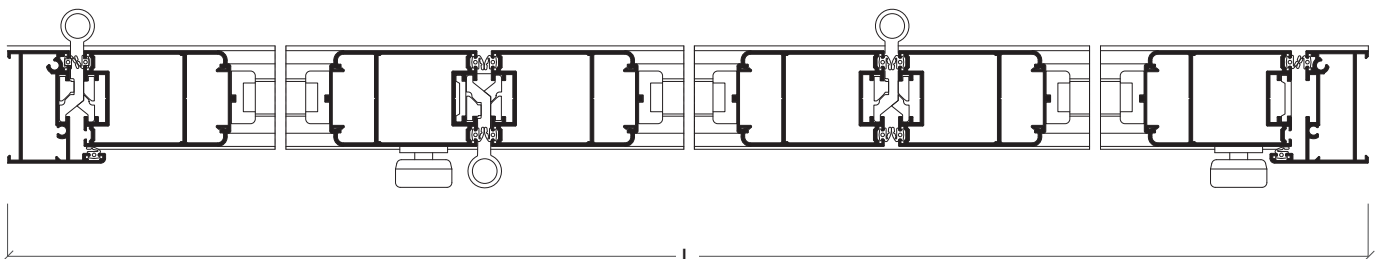

Porta 5 folhas harmónio abertura exterior com vidro

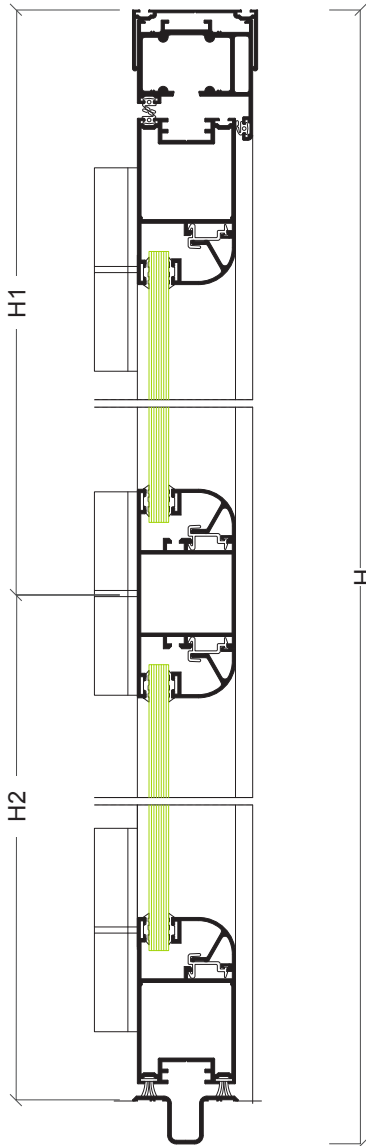
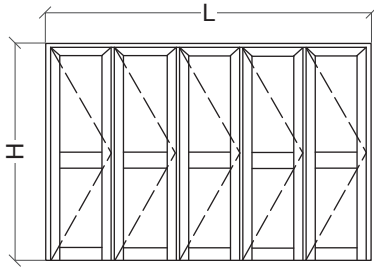

Perfis

| Desenho | Ref | Descrição | Corte | Quant | Medida |
|---------|-------|----------------------|-------|---------------|------------|
| | XP-20 | Distanciador de aro | | 1 | L |
| | XP-21 | Aro fixo para carril | | 1 | L |
| | XP-03 | Aro fixo | | 2 | H-31 mm |
| | XP-22 | Aro móvel de porta | | 10 | L/5-17 mm |
| | | | | 10 | H-47 mm |
| | AZ-09 | Travessa | | 5 | L/5-103 mm |
| | AZ-06 | Bite redondo | | 10 | H1-100 mm |
| | | | | 10 | H2-67 mm |
| | AX-29 | Bite redondo | | 20 | L/5-113 mm |
| | AX-33 | Mola bite | | A cada 300 mm | 80 mm |
| | XP-23 | Guia de embutir | | 1 | L |
| | AX-19 | Vareta | | 2 | Apro. H |

Dimensões máximas: 800x2500 mm por folha
Peso máximo: 40 Kg por folha

Acessórios e Juntas

| Referência | Descrição | Quantidade |
|-------------|---------------------------------|----------------|
| 30 94 01 04 | Jogo parafusos distanciadores | 3 |
| 30 94 01 07 | Fecho de embutir portada | 3 |
| 30 94 01 08 | Aplique fixador | 3 |
| 30 94 01 06 | Rolamentos/dobradiças harmónio | 2 |
| 30 94 01 23 | Cremona 4 folhas (opcional a A) | 3 |
| 30 94 01 24 | Dobradiça | 11 |
| 30 94 01 26 | Distanciador de aro | 1 a cada 50 cm |
| 30 94 01 33 | Esquadro porta | 20 |
| 30 92 00 41 | Terminal fecho | 3 |
| 30 92 00 42 | Terminal fecho inferior | 3 |
| 30 92 01 50 | União topos porta | 10 |
| 30 94 01 46 | Junta interior/exterior | 2L+5L/5+22H |
| 30 95 00 30 | Pelúcia 7x7 mm | 10L/5 |
| --- | Junta exterior vidro | 4L+10H |
| --- | Junta interior vidro | 4L+10H |

Vidros

| | |
|------------|-----------|
| L/5-126 mm | H1-123 mm |
| L/5-126 mm | H2-90 mm |

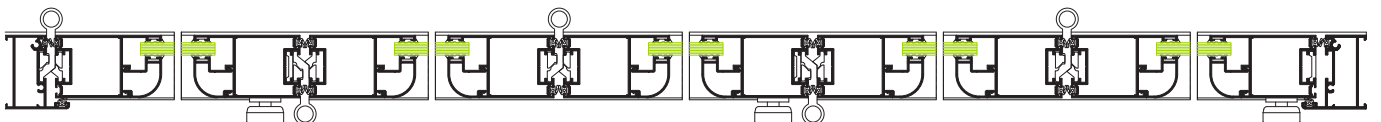

Janela 1 folha correr

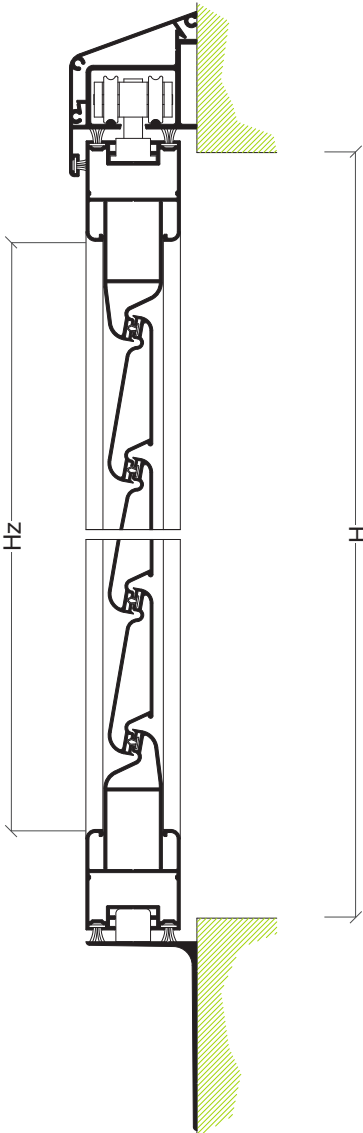
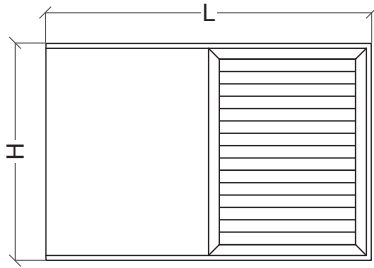

Perfis

| Desenho | Ref | Descrição | Corte | Quant | Medida |
|---------|-------|-------------------------|-------|----------------|--------------|
| | XP-07 | Guia superior de correr | | 1 | 2L+59 mm |
| | XP-05 | Aro móvel de janela | | 2 | L+10 mm |
| | | | | 2 | L+10 mm |
| | XP-01 | Meia lâmina | | 2 | L-99 mm |
| | Z-53 | Lâmina | | Segundo altura | L-89 mm |
| | AX-19 | Vareta | | 2 | Apro. H/2 mm |
| | XP-06 | Tampa da guia superior | | 1 | 2L+59 mm |
| | XP-08 | Tampa lateral de correr | | 2 | H+10 mm |
| | XP-15 | Guia inferior de correr | | 1 | 2L+59 mm |

Acessórios e Juntas

| Referência | Descrição | Quantidade |
|-------------|------------------------------------|------------------|
| 30 94 01 04 | Jogo parafusos distanciadores | 1 |
| 30 94 01 05 | Rolamentos portada de correr | 2 |
| 30 94 01 07 | Fecho de embutir portada | 1 |
| 30 94 01 27 | Esquadro de janela | 4 |
| 30 94 01 34 | Fecho superior correr | 2 |
| 30 94 01 35 | Fecho inferior correr | 2 |
| 30 94 01 36 | Tampa lateral | 2 |
| 30 92 00 41 | Terminal fecho | 2 |
| --- | Jogo portalâminas (segundo altura) | 1 |
| 30 93 01 40 | Vedante lâminas | Nº lâminas + 1 L |
| 30 95 00 10 | Pelúcia 7x9 mm | 4L+2H+12L |

Portalâminas

| |
|--------------|
| Hz = H-75 mm |
|--------------|

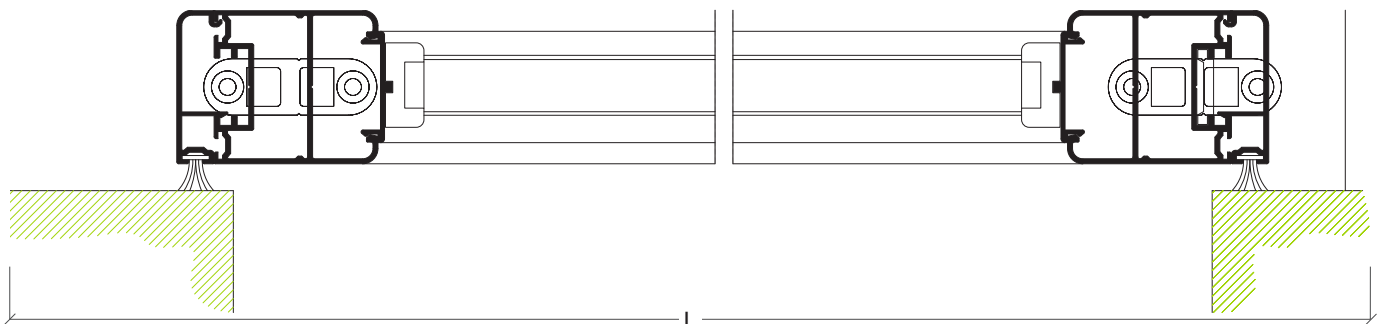

Janela 2 folhas correr

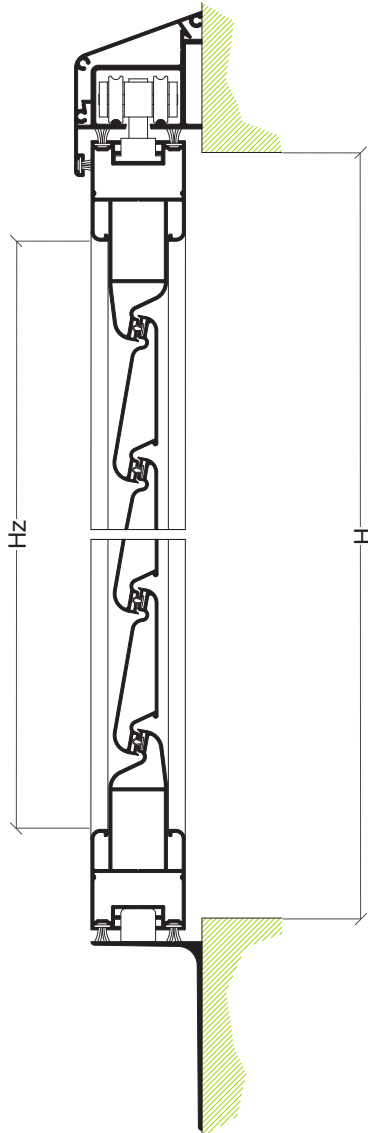
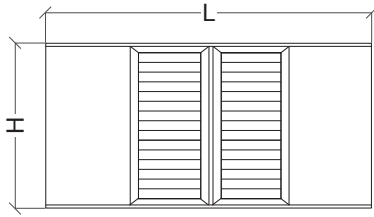

Perfis

| Desenho | Ref | Descrição | Corte | Quant | Medida |
|---------|-------|-------------------------|-------|----------------|--------------|
| | XP-07 | Guia superior de correr | | 1 | 2L+19 mm |
| | XP-05 | Aro móvel de janela | | 4 | L/2 mm |
| | | | | 4 | H+10 mm |
| | XP-01 | Meia lâmina | | 4 | L/2-109 mm |
| | Z-53 | Lâmina | | Segundo altura | L/2-99 mm |
| | AX-19 | Vareta | | 2 | Apro. H/2 mm |
| | XP-06 | Tampa da guia superior | | 1 | 2L+19 mm |
| | XP-08 | Tampa lateral de correr | | 2 | H+10 mm |
| | XP-15 | Guia inferior de correr | | 1 | 2L+19 mm |
| | XP-17 | Perfil de batente | | 2 | H-7 mm |

Acessórios e Juntas

| Referência | Descrição | Quantidade |
|-------------|------------------------------------|------------------|
| 30 94 01 04 | Jogo parafusos distanciadores | 2 |
| 30 94 01 05 | Rolamentos portada de correr | 4 |
| 30 94 01 07 | Fecho de embutir portada | 2 |
| 30 94 01 12 | Jogo topos para perfil batente | 2 |
| 30 94 01 27 | Esquadro de janela | 8 |
| 30 94 01 34 | Fecho superior correr | 3 |
| 30 94 01 35 | Fecho inferior correr | 3 |
| 30 94 01 36 | Tampa lateral | 2 |
| 30 92 00 41 | Terminal fecho | 4 |
| --- | Jogo portalâminas (segundo altura) | 2 |
| 30 93 01 40 | Vedante lâminas | Nº lâminas + L/2 |
| 30 95 00 10 | Pelúcia 7x9 mm | 8L/2+4H+12L |

21

Portalâminas

| |
|--------------|
| Hz = H-75 mm |
|--------------|

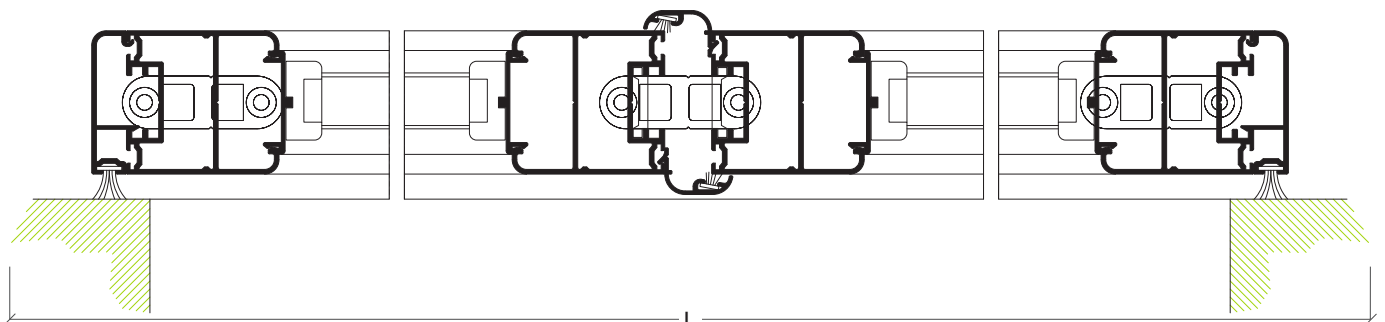

Janela 2 folhas correr afastada

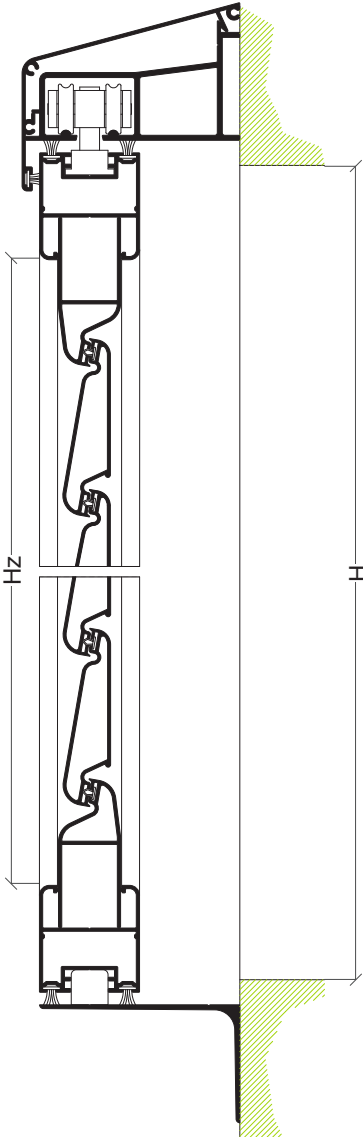
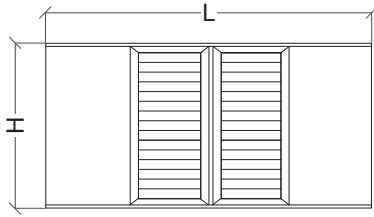

Perfis

| Desenho | Ref | Descrição | Corte | Quant | Medida |
|---------|-------|-------------------------------|-------|----------------|--------------|
| | XP-13 | Guia superior de correr larga | | 1 | 2L+19 mm |
| | XP-05 | Aro móvel de janela | | 4 | L/2 mm |
| | | | | 4 | H+10 mm |
| | XP-01 | Meia lâmina | | 4 | L/2-109 mm |
| | Z-53 | Lâmina | | Segundo altura | L/2-99 mm |
| | AX-19 | Vareta | | 2 | Apro. H/2 mm |
| | XP-12 | Tampa guia superior larga | | 2 | 2L+19 mm |
| | XP-14 | Tampa lateral de correr larga | | 2 | H+10 mm |
| | XP-15 | Guia inferior de correr | | 1 | 2L+19 mm |
| | XP-17 | Perfil de batente | | 2 | H-7 mm |

Acessórios e Juntas

| Referência | Descrição | Quantidade |
|-------------|------------------------------------|------------------|
| 30 94 01 04 | Jogo parafusos es | 2 |
| 30 94 01 05 | Rolamentos portada de correr | 4 |
| 30 94 01 07 | Fecho de embutir portada | 2 |
| 30 94 01 12 | Jogo topos para perfil batente | 2 |
| 30 94 01 27 | Esquadro de janela | 8 |
| 30 94 01 34 | Fecho superior correr | 3 |
| 30 94 01 35 | Fecho inferior correr | 3 |
| 30 94 01 36 | Tampa lateral | 2 |
| 30 92 00 41 | Terminal fecho | 4 |
| --- | Jogo portalâminas (segundo altura) | 2 |
| 30 93 01 40 | Vedante lâminas | Nº lâminas + L/2 |
| 30 95 00 10 | Pelúcia 7x9 mm | 8L/2+4H+12L |

Portalâminas

| |
|--------------|
| Hz = H-75 mm |
|--------------|

