

[www.dineru.com](http://www.dineru.com)



**GP**

**Systeme de Portails**

## Système GP

### Système de grilles et balaustrades

#### Caractéristiques du système

Système d'aluminium pour exécution de portails battants ou coulissants pour l'entrée des maisons, permettant l'exécution de grilles avec la même apparence.

Produit exécuté en conformité à la norme européenne de réglementation général EN 13241-1 des de performance et de sécurité.

Le système GP combine les concepts de qualité, de durabilité et de l'élégance, possédant également une gamme d'accessoires d'application et maintenance réduite.

Les modèles de grille sont compatibles avec l'automatisation classique pour ouverture battant u coulissant.

#### Profils d'aluminium

Les profils d'aluminium sont extrudées dans l'alliage d'aluminium 6060 pour architecture d'accord la norme NP EN 12020-02.

Les profils en aluminium qui composent le système GP sont laqués par le label de qualité Qualicoat, y compris la classe Seaside (équivalent Qualmarine), ou anodisé satisfaisant les exigences du label de qualité Qualanod.

2

### Grille de batant

- Section des principales profils de 50 mm avec une épaisseur moyenne de 2,5 mm.
- Possibilité d'exécution de la grille avec 1 ou 2 feuilles d'ouverture intérieure ou extérieure avec d'option de système anti-coincement de les doigts.
- Il existe plusieurs types de remplissage de 9 mm à 20 mm.
- Union des profils fait par des vis spéciales d'ouverture avec un traitement anti-corrosion.

### Grille coulissant

- Section des principales profils de 50 mm avec une épaisseur moyenne de 2,5 mm.
- Possibilité d'exécution de grille coulissant avec plusieurs types de remplissage de 9 mm à 20 mm.
- Union des profils fait par des vis spéciales d'ouverture avec un traitement anti-corrosion.

### Balaustrade

- Section des principales profils de 50 mm avec une épaisseur moyenne de 2,5 mm.
- Identique typologie de profils utilisée dans la execution de la balustrade.
- Union des profils fait par des vis spéciales d'ouverture avec un traitement anti-corrosion.
- Profils verticaux auto-ajustables.

### Dimensionnement et manoeuvrabilité

- Dimensions maximales pour grille batent de 1 feuille\*: 1600 mm (L) x 2200 mm (H)
- Dimensions maximales pour grille batent de 2 feuilles\*: 5500 mm (L) x 2000 mm (H)
- Dimensions maximales pour grille coulissant: 6000 mm (L) x 2200 mm (H)

\* Dimensionnement maximale variable en fonction de la typologie de remplissage et quinquillarie d'ouverture.

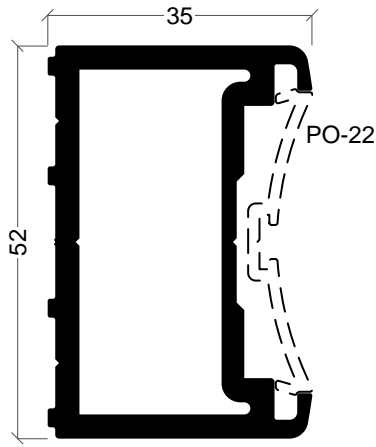

**PO-11**  
Aro fixo

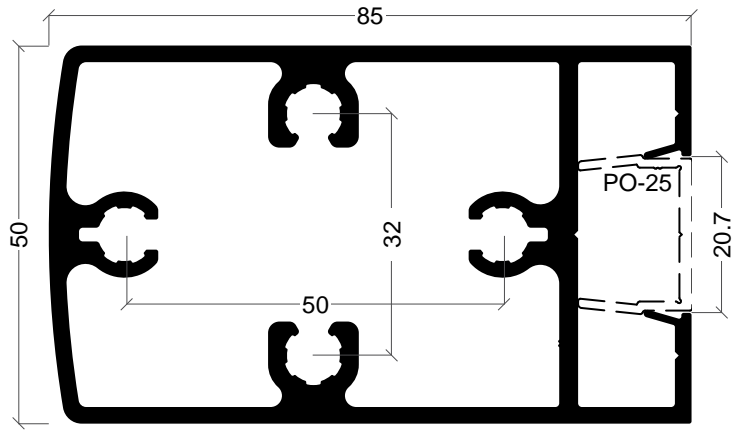

**PO-12**  
Travessa

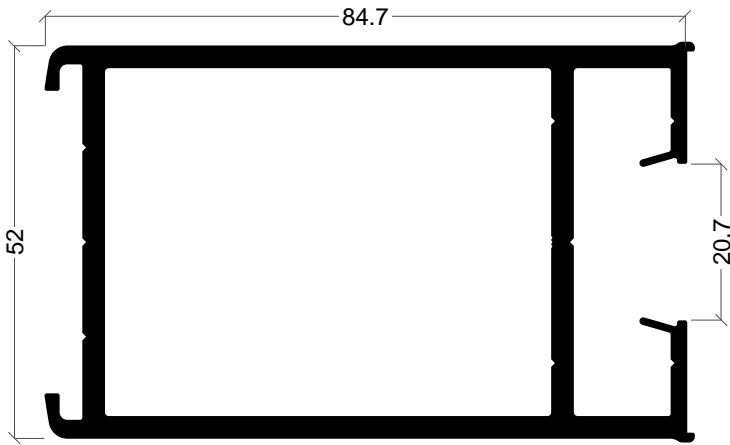

**PO-13**  
Montante

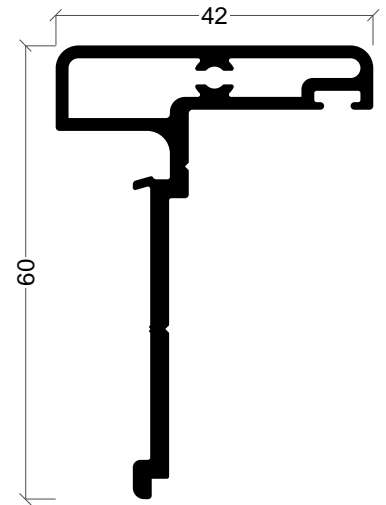

**PO-20**  
Inversor

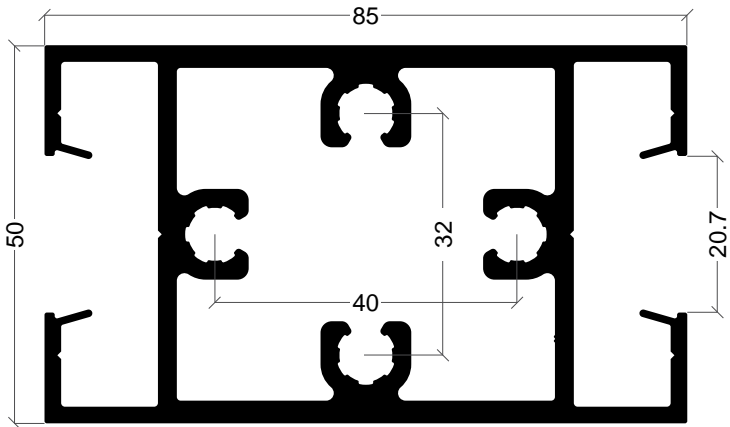

**PO-16**  
Travessa intermédia

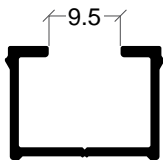

**PO-15**  
Redutor

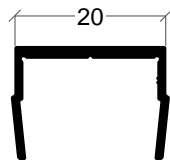

**PO-25**  
Perfil tampa

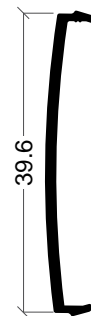

**PO-14**  
Tampa

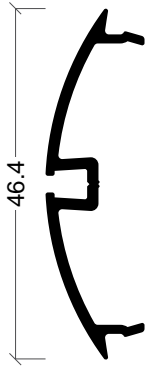

**PO-21**  
Suplemento de batente



**PO-22**  
Suplemento de batente

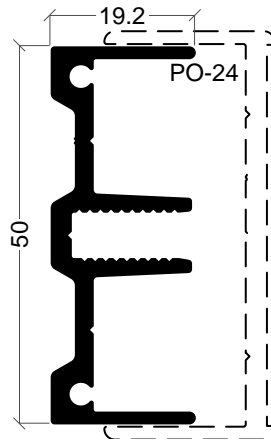

**PO-23**  
Remate gradeamento

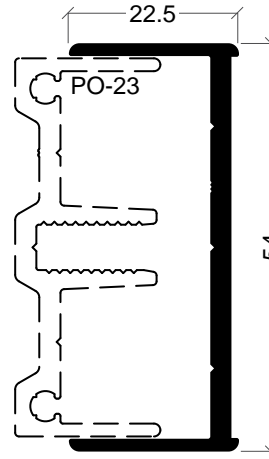

**PO-24**  
Remate gradeamento

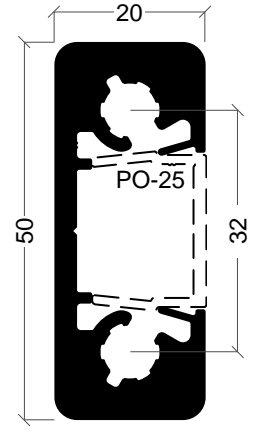

**PO-26**  
Travessa gradeamento

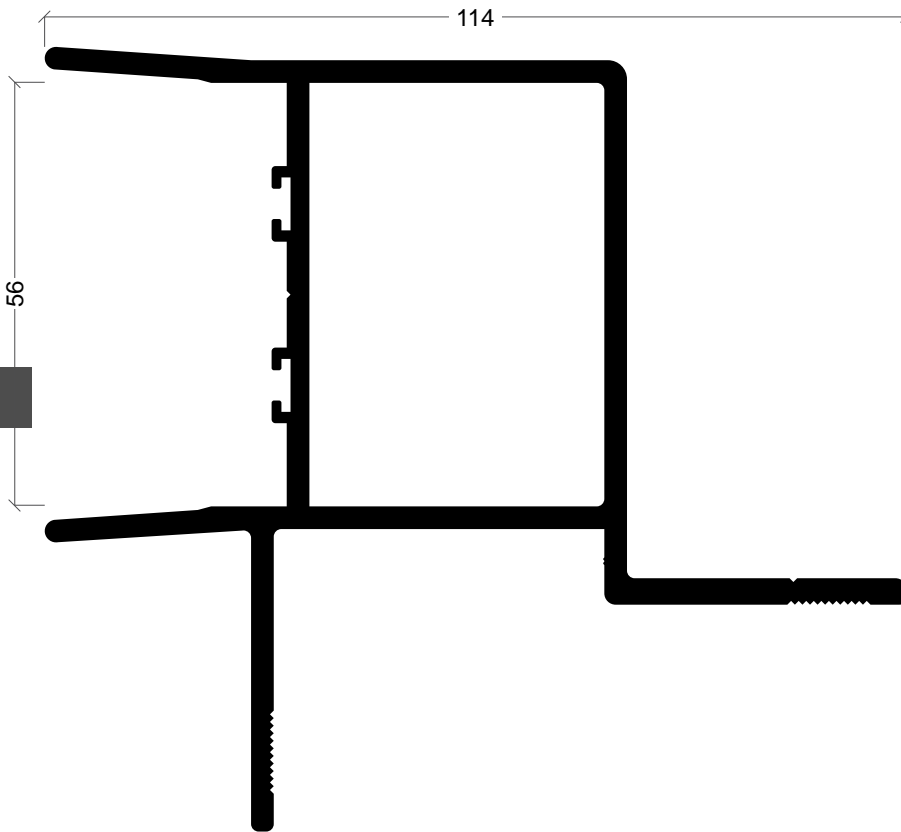

**PO-04**  
Prumo fixo correr

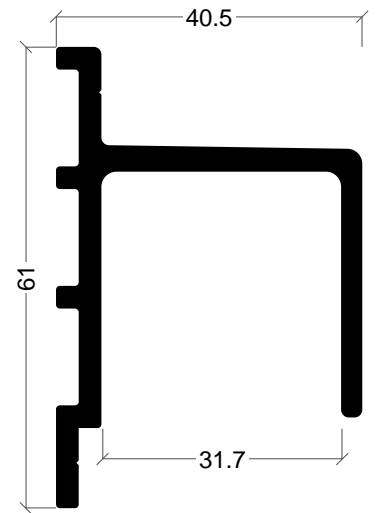

**PO-09**  
Guia correr

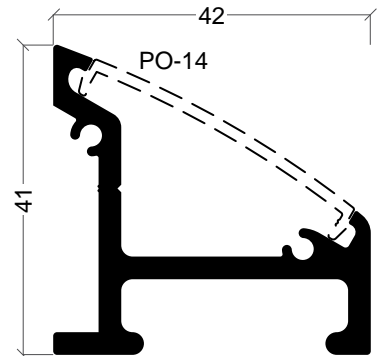

**PO-19**  
Guia correr com tampa

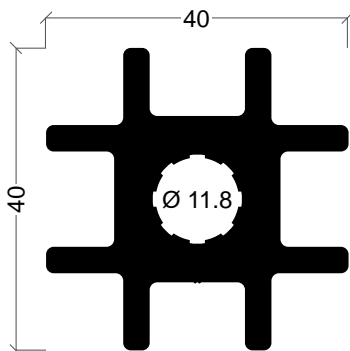

**PO-17**  
Perfil de reforço

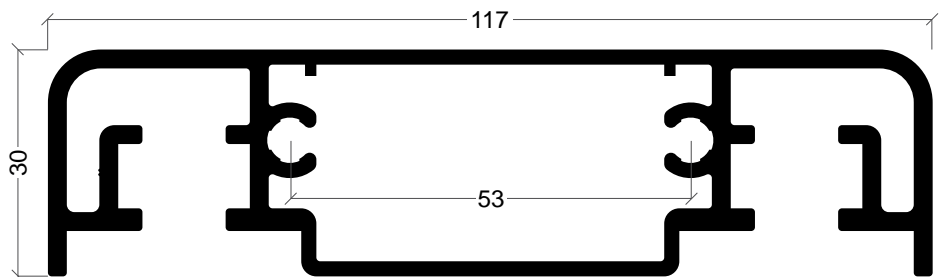

**PO-18**  
Ponte para roletos

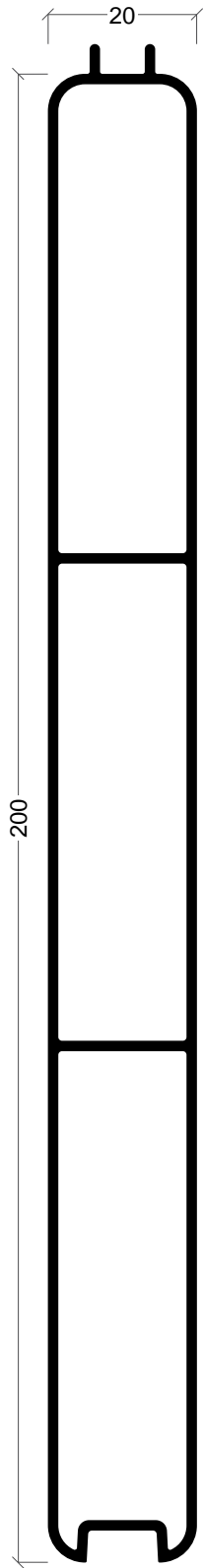

**W-12**  
Lâmina 200 mm

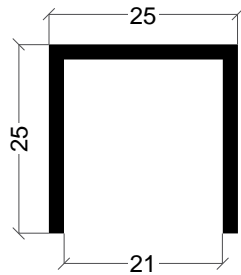

**U-11**  
Perfil de remate

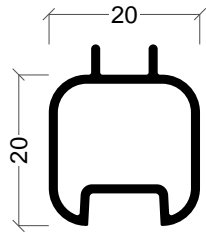

**W-16**  
Lâmina 20 mm

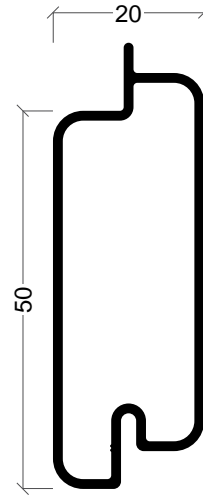

**W-26**  
Lâmina 50 mm

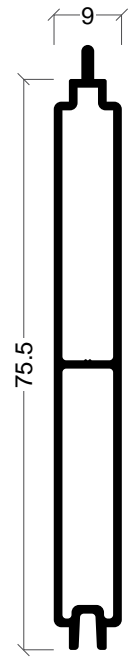

**W-23**  
Lâmina 75.5 mm

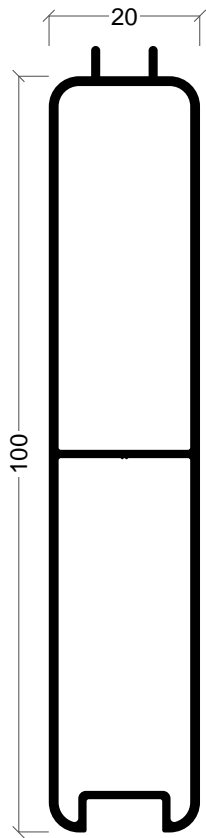

**W-27**  
Lâmina 100 mm

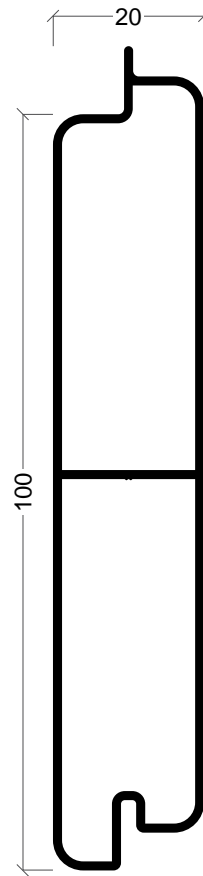

**W-25**  
Lâmina 100 mm

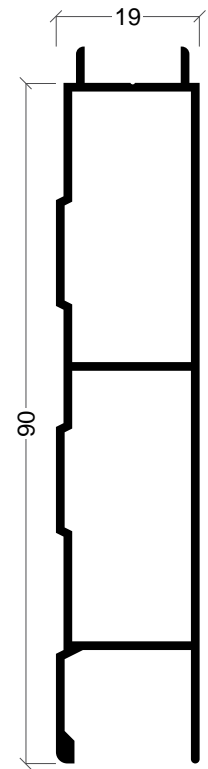

**W-21**  
Lâmina 90 mm

Referência	A	B	Esp.
Q-02	20	-	2
P-11	30	20	1.3
P-04	40	20	1.2
Q-20	60	-	2
Q-09	65	-	1.5
P-21	80	20	1.5
P-14 *	100	20	1.3

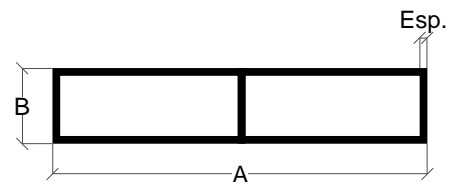
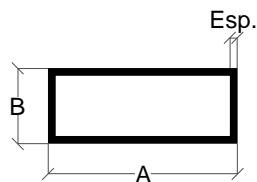
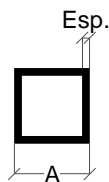

\* Parede ao centro

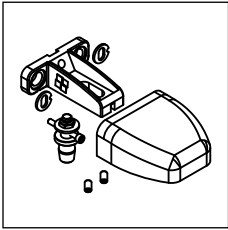

**30 01 60 10/11**  
Pivot superior E20 mm  
(branco/preto)

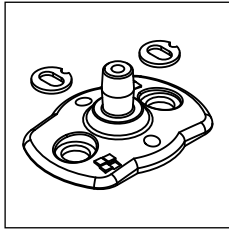

**30 01 60 13/14**  
Pivot inferior E20 mm  
(branco/preto)

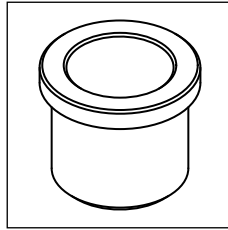

**30 01 60 19**  
Casquilho nylon E20 mm  
(branco)

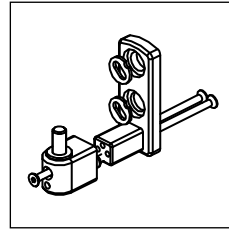

**30 01 60 20/21**  
Conjunto pivot E12 mm  
(branco/preto)

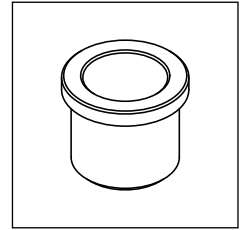

**30 01 60 25**  
Casquilho nylon E12 mm  
(branco)

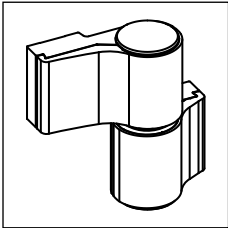

**30 01 60 30/31**  
Dobradiça 2 abas 3D lisa  
(branco/preto)

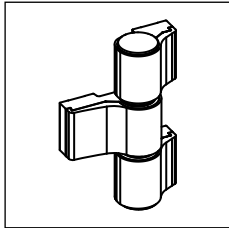

**30 01 60 33/34**  
Dobradiça 3 abas 3D lisa  
(branco/preto)

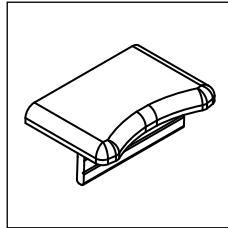

**30 01 60 40/41**  
Topo PO-11 + PO-22  
(branco/preto)

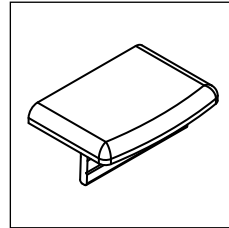

**30 01 60 43/44**  
Topo PO-11 (branco/  
preto)

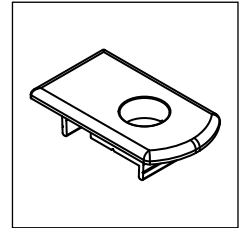

**30 01 60 46/47**  
Topo PO-13 + PO-21  
E20 mm (branco/preto)

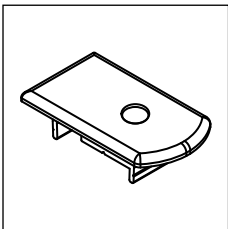

**30 01 60 49/50**  
Topo PO-13 + PO-21  
E12 mm (branco/preto)

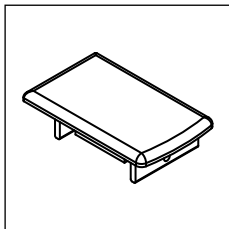

**30 01 60 52/53**  
Topo PO-13 (branco/  
preto)

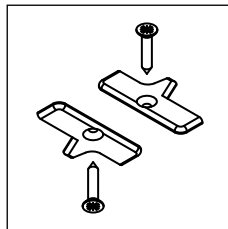

**30 01 60 55/56**  
Jogo topos inversor  
PO-20 (branco/preto)

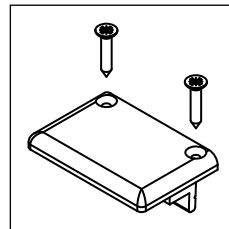

**30 01 60 58/59**  
Topo fixo para gradeamento  
(branco/preto)

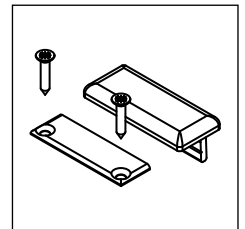

**30 01 60 61/62**  
Jogo topos reg. para  
gradeamento (branco/preto)

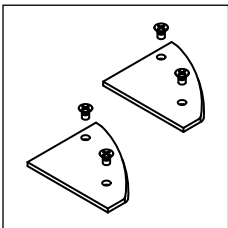

**30 01 60 64/65**  
Jogo topos guia PO-19  
(branco/preto)

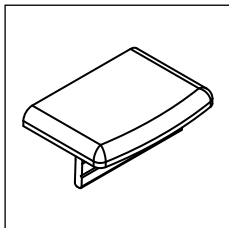

**30 01 60 67/68**  
Topo prumo PO-04  
(branco/preto)

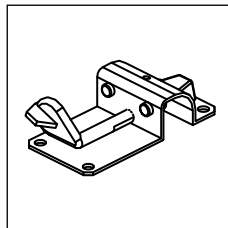

**30 01 60 80**  
Batente central inox  
abertura manual

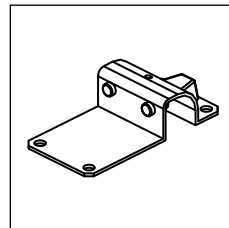

**30 01 60 81**  
Batente central inox  
abertura motorizada

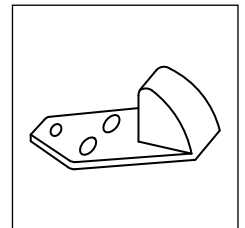

**30 01 60 82/83**  
Batente central abertura  
motorizada (branco/preto)

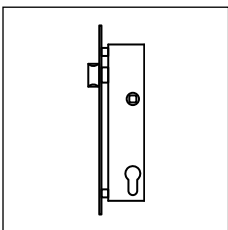

**30 01 60 90**  
Fechadura prumo  
batente 40 mm

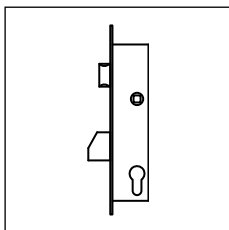

**30 01 60 91**  
Fechadura prumo  
batente 35 mm

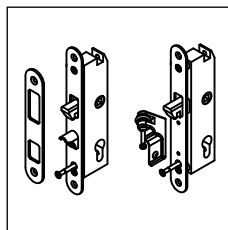

**30 01 60 95/96**  
Fechaduras  
semi-automáticas correr

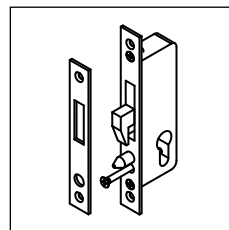

**30 01 60 97**  
Fechadura manual correr

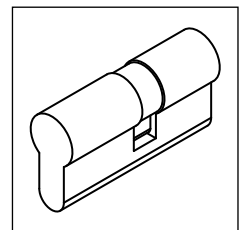

**30 01 61 00**  
Canhão Euro cromado

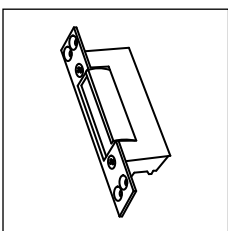

**30 01 61 10**  
Testa elétrica

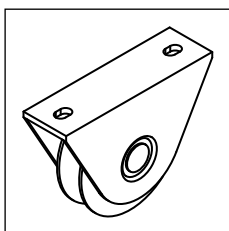

**30 01 61 20**  
Roda com suporte  
triangular

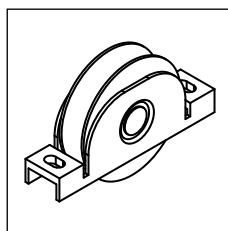

**30 01 61 21**  
Roda com suporte  
inferior

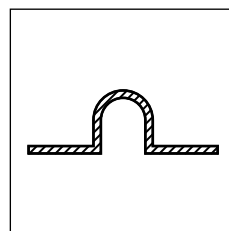

**30 01 61 25/26**  
Calha de aço em U (3  
mts / 6 mts)

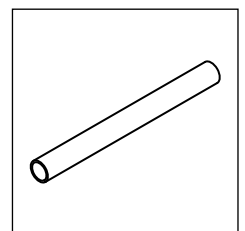

**30 01 61 27**  
União para calha

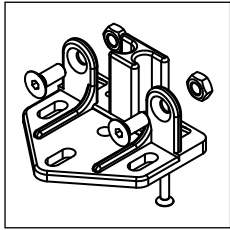

**30 01 61 30/31**  
Fixador para ponte  
PO-18 (branco/preto)

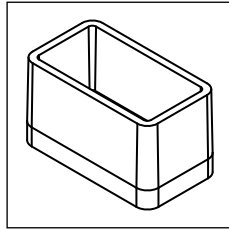

**30 01 61 33**  
Fixador interior para  
ponte PO-18

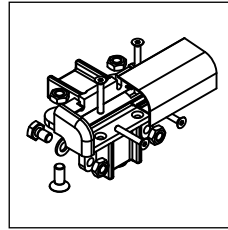

**30 01 61 34/35**  
Ângulo para ponte PO-18  
(branco/preto)

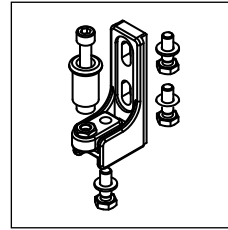

**30 01 61 37/38**  
Suporte regulável para  
rolete (branco/preto)

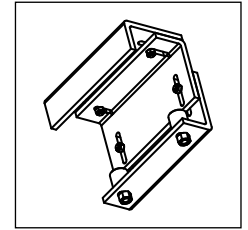

**30 01 61 40/41**  
Ponte com roletos 30  
mm (branco/preto)

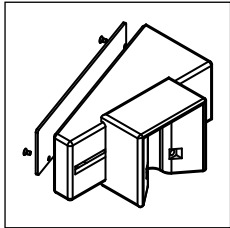

**30 01 61 50/51**  
Conjunto de fecho correr  
(branco/preto)

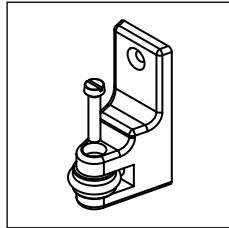

**30 01 61 53/54**  
Engate para fecho correr  
(branco/preto)

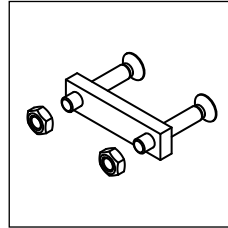

**30 01 61 56**  
Gache fecho correr

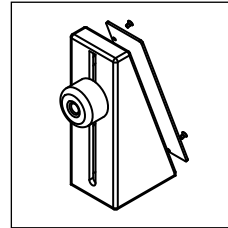

**30 01 61 57/58**  
Batente correr (branco/  
preto)

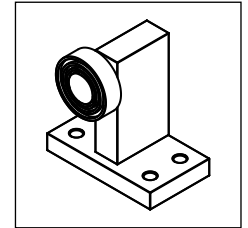

**30 01 61 60/61**  
Batente correr alumínio  
(branco/preto)

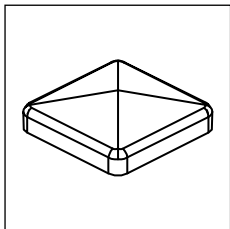

**30 01 61 70/71**  
Topo piramidal 60x60  
(branco/preto)

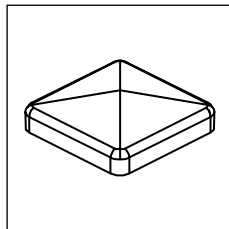

**30 01 61 73/74**  
Topo piramidal 65x65  
(branco/preto)

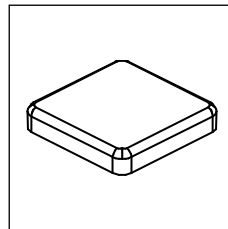

**30 01 61 76/77**  
Topo liso 60x60 (branco/  
preto)

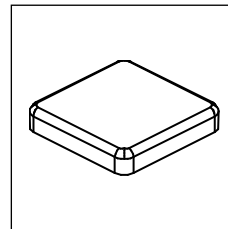

**30 01 61 79/80**  
Topo liso 65x65 (branco/  
preto)

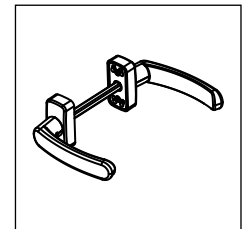

**30 92 22 82/83**  
Puxador duplo (branco/  
preto)

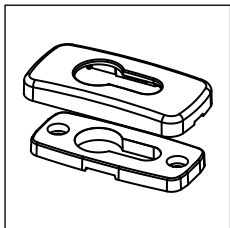

**30 92 22 85/86**  
Escudo para canhão  
(branco/preto)

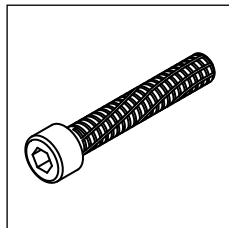

**31 01 60 00**  
Parafuso M8x50  
dacromet

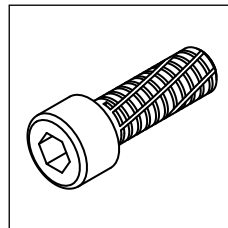

**31 01 60 01**  
Parafuso M8x25  
dacromet

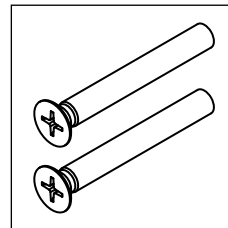

**31 01 60 02**  
Jogo parafusos M5x45  
A2

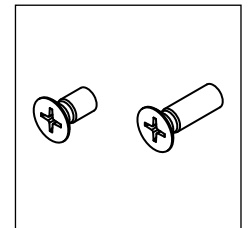

**31 01 60 03**  
Jogo parafusos M5 A2

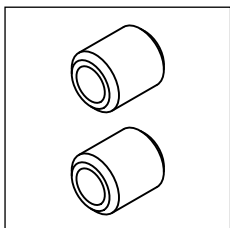

**31 01 60 04**  
Jogo separador 714

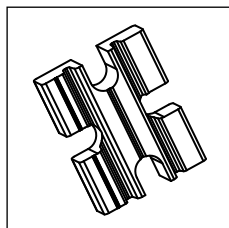

**31 01 60 09**  
Calço de alumínio de  
aperto

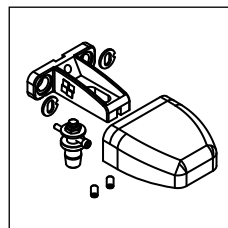

**31 01 60 12 \***  
Pivot superior E20  
(bruto)

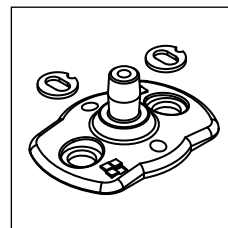

**31 01 60 15 \***  
Pivot inferior E20 (bruto)

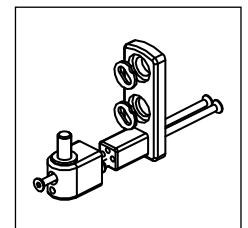

**31 01 60 22 \***  
Conjunto pivot E12  
(bruto)

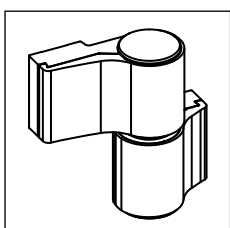

**31 01 60 32**  
Dobraçã 2 abas 3D lisa  
(bruto)

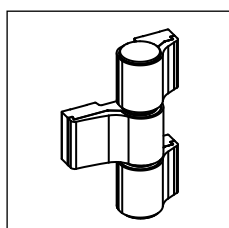

**31 01 60 35**  
Dobraçã 3 abas 3D lisa  
(bruto)

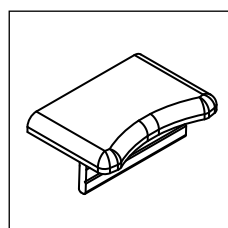

**31 01 60 42**  
Topo PO-11 + PO-22  
(bruto)

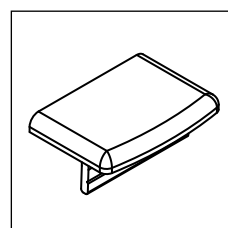

**31 01 60 45**  
Topo PO-11 (bruto)

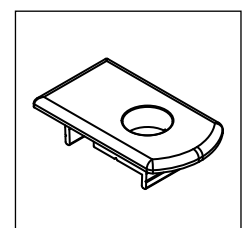

**31 01 60 48**  
Topo PO-13 + PO-21  
E20 (bruto)

\* Só para lacar

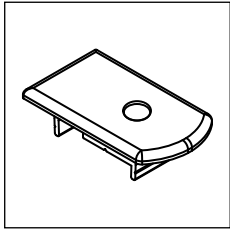

**31 01 60 51**  
Topo PO-13 + PO-21  
E12 (bruto)

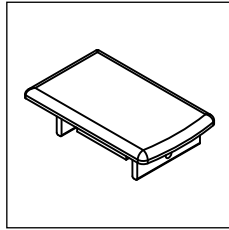

**31 01 60 54**  
Topo PO-13 (bruto)

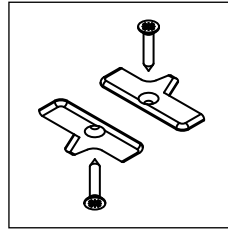

**31 01 60 57**  
Jogo topos inversor  
PO-20 (bruto)

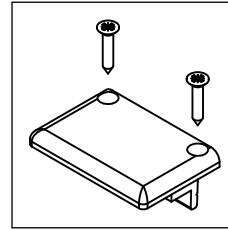

**31 01 60 60**  
Topo fixo para  
gradeamento (bruto)

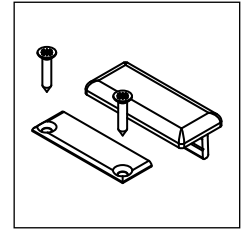

**31 01 60 63**  
Jogo topos reg. para  
gradeamento (bruto)

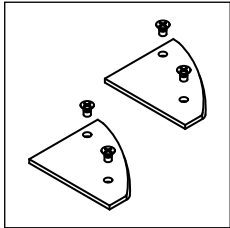

**31 01 60 66**  
Jogo topos guia PO-19  
(bruto)

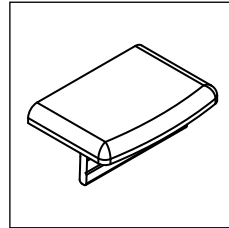

**31 01 60 70**  
Topo prumo PO-04  
(bruto)

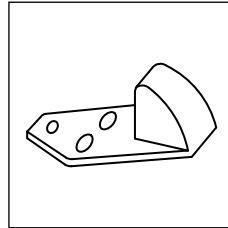

**31 01 60 84 \***  
Batente central abertura  
motorizada (bruto)

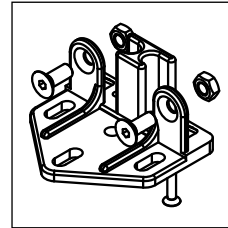

**31 01 61 32 \***  
Fixador para ponte  
PO-18 (bruto)

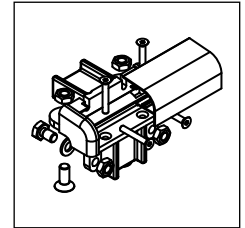

**31 01 61 36 \***  
Ângulo para ponte PO-18  
(bruto)

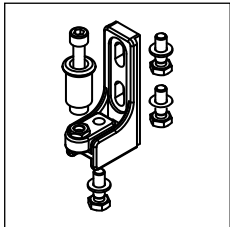

**31 01 61 39 \***  
Suporte regulável para  
rolete (bruto)

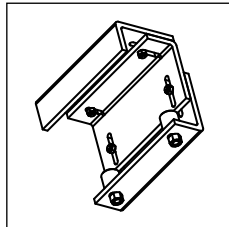

**31 01 61 42**  
Ponte com roletos 30  
mm (bruto)

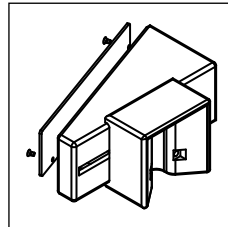

**31 01 61 52 \***  
Conjunto de fecho correr  
(bruto)

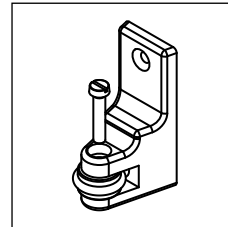

**31 01 61 55 \***  
Engate para fecho correr  
(bruto)

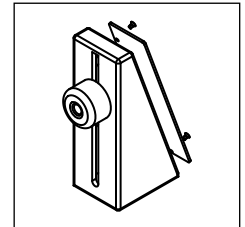

**31 01 61 59 \***  
Batente correr (bruto)

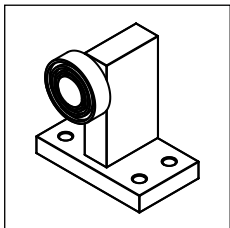

**31 01 61 62**  
Batente correr alumínio  
(bruto)

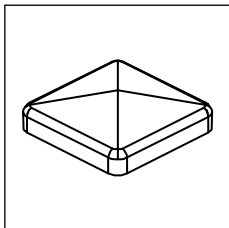

**31 01 61 72 \***  
Topo piramidal 60x60  
(bruto)

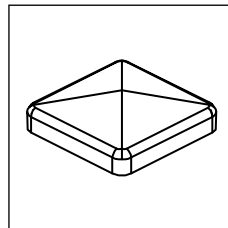

**31 01 61 75 \***  
Topo piramidal 65x65  
(bruto)

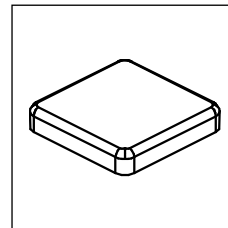

**31 01 61 78 \***  
Topo liso 60x60 (bruto)

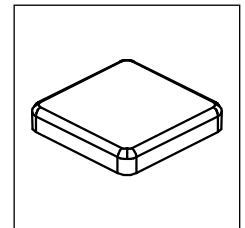

**31 01 61 81 \***  
Topo liso 65x65 (bruto)

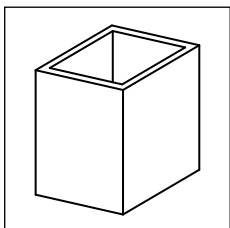

**31 01 61 82 \***  
Fixador pavimento 60x60  
(bruto)

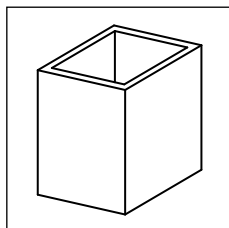

**31 01 61 85 \***  
Fixador pavimento 65x65  
(bruto)

Referência	Desenho	Descrição
30 01 62 00		Junta para inversor (preto)
30 60 00 14		Perfil pelúcia 18 mm (3 mts preto)
30 60 00 20		Perfil pelúcia 29 mm (3 mts preto)
30 80 10 22		Junta cunha recartilhada 7 mm
30 93 00 65		Junta cunha 5 mm (preto)
30 93 00 66		Junta cunha 4 mm (preto)
30 93 00 67		Junta cunha 2 mm (preto)
30 93 00 68		Junta cunha 6/7 mm (preto)
30 93 00 69		Junta cunha 8/9 mm (preto)
30 94 01 48		Junta de correr
30 95 00 10		Pelúcia Stop-Fin



Lp = Largura espaço para o portão  
 Lf = Largura da folha  
 LTpc = Largura do portão de correr  
 Lg = Largura do gradeamento

Hp = Altura do portão  
 Hpilar = Altura do pilar de sustentação  
 HTP = Altura do portão incluído pivot (batente) ou ponte (correr)

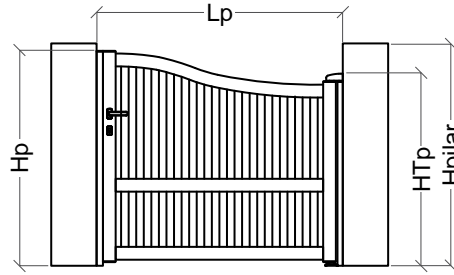
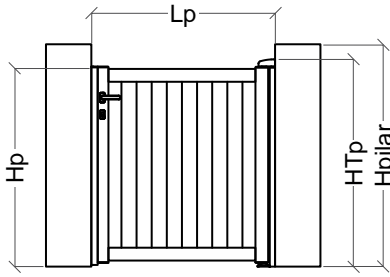
**Portão de 1 Folha**
**Dimensões mínimas:**

Lp mini: 600 mm

Hp mini: 600 mm

Hpilar > 100 mm (mínimo) que HTP ou Hpilar > 100 mm (mínimo) que Hp

**Dimensões máximas\*:**

Lp maxi: 1600 mm

Hp maxi: 2200 mm

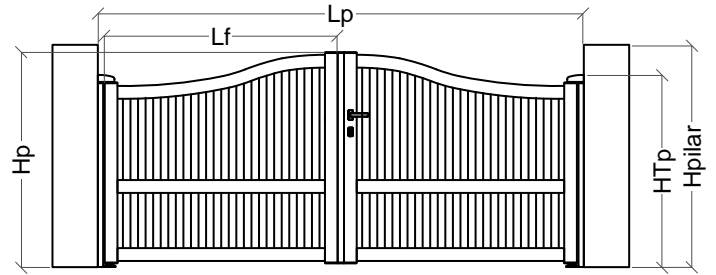
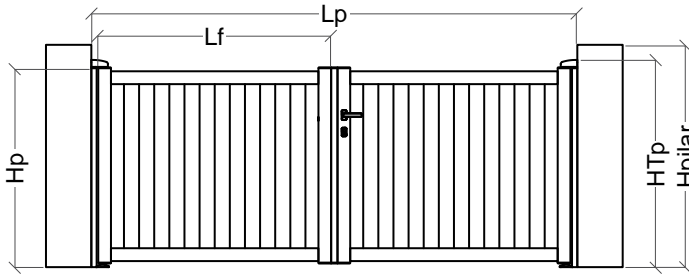
**Portão de 2 Folhas**
**Dimensões mínimas:**

Lp mini: 1200 mm

Hp mini: 600 mm

Hpilar > 100 mm (mínimo) que HTP ou Hpilar > 100 mm (mínimo) que Hp

**Dimensões máximas\*:**

Lp maxi: 5500 mm - Lf maxi = 2716 mm

Hp maxi: 2000 mm

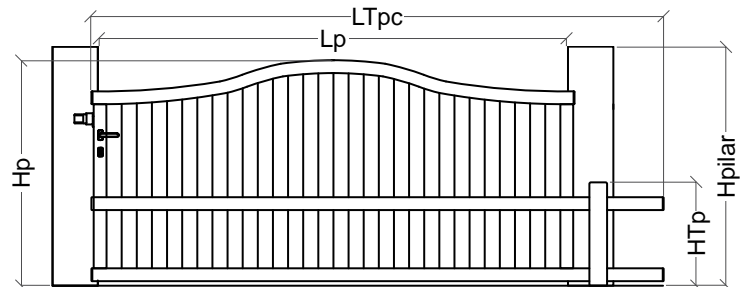
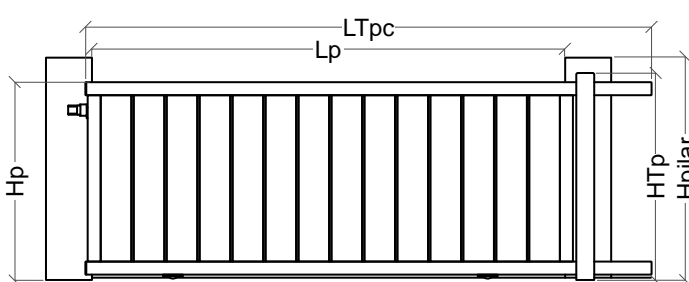
**Portão de Correr**
**Dimensões mínimas:**

Lp mini: 600 mm

Hp mini: 600 mm

Hpilar > 100 mm (mínimo) que HTP ou Hpilar > 100 mm (mínimo) que Hp

Peso máximo: 300 kg

**Dimensões máximas\*:**

Lp maxi: 4000 mm (com 2 rodas) ou 4001 mm - 6000 mm (com 4 rodas)

Hp maxi: 2200 mm

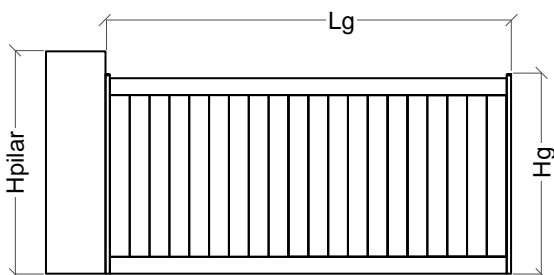
**Gradeamento**
**Dimensões mínimas:**

Lg mini: 264 mm

Hg mini: 250 mm

**Dimensões máximas\*:**

Lg maxi: 6500 mm

Hg maxi: 2200 mm

\* Sujeito a confirmação em função da tipologia

## Portão de 1 Folha Abrir com Dobradiças

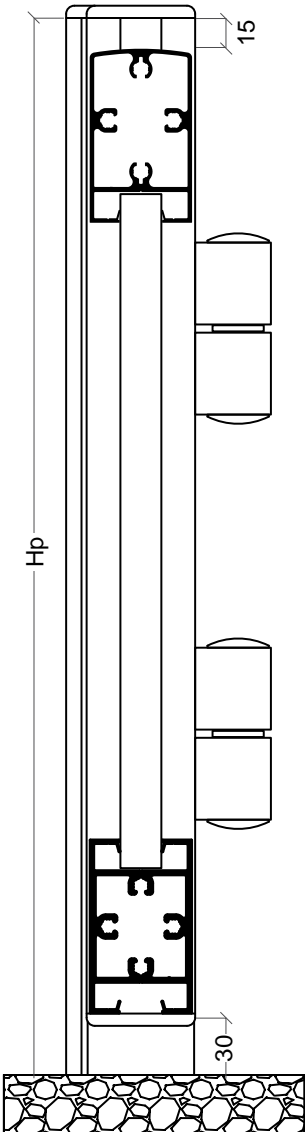
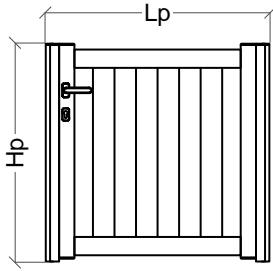

### Perfis

Desenho	Ref	Descrição	Corte	Quant	Medida
	PO-11	Aro fixo		1	Hp
	PO-12	Travessa		1	Lp-264 mm
	PO-13	Montante		2	Hp-30 mm
	PO-14	Tampa		2	Hp-30 mm
	PO-16	Travessa inferior		1	Hp-264 mm
	PO-20	Inversor		2	Hp
	PO-25	Perfil tampa		2	20 mm
	W-27	Lâmina		várias	Hp-186 mm

### Acessórios e Juntas

Referência	Descrição	Quantidade
30 01 60 30	Dobradiça 2 abas 3D lisa (Hp < 1500 mm)	2
30 01 60 43	Topo PO-11	2
30 01 60 52	Topo PO-13	4
30 01 60 55	Jogo topo inversor	2
30 01 60 90	Fechadura prumo	1
30 01 61 00	Canhão cromado	1
30 01 61 10	Testa elétrica	1
30 01 62 00	Junta inversor	2Hp
30 92 22 82	Puxador duplo	1
30 92 22 85	Escudo para canhão	2
31 01 60 00	Parafuso M8x50 dacromet	16
31 01 60 09	Calço de aperto	4

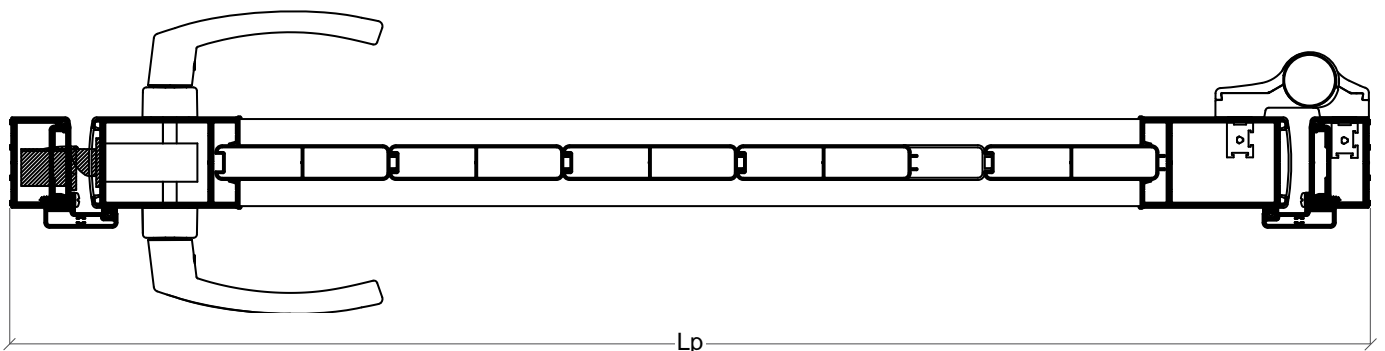

## Portão de 2 Folhas Abrir com Conjunto Pivot E20

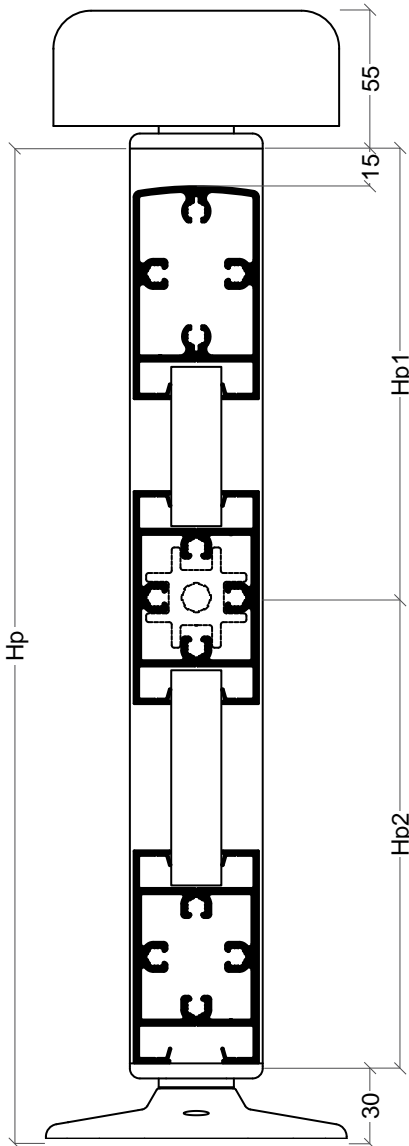
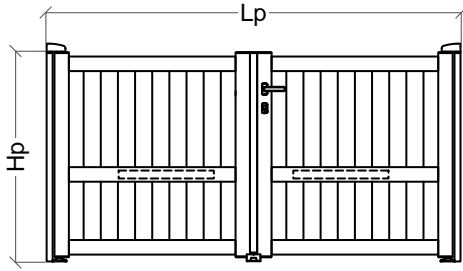

### Perfis

Desenho	Ref	Descrição	Corte	Quant	Medida
	PO-11	Aro fixo		2	Hp
	PO-12	Travessa		2	Lp/2-220 mm
	PO-13	Montante		2	Hp-30 mm
	PO-14	Tampa		1	Hp-30 mm
	PO-16	Travessa intermédia		4	Lp/2-220 mm
	PO-20	Inversor		1	Hp-30 mm entalhe no extremo inferior
	PO-21	Suplemento		2	Hp-30 mm
	PO-22	Suplemento		2	Hp
	PO-25	Perfil tampa		4	20 mm
	W-27	Lâmina		várias	Hp1-114 mm
				várias	Hp2-129 mm
	PO-17	Perfil de reforço (para automatismo)		2	800 mm

### Acessórios e Juntas

Referência	Descrição	Quantidade	
		Manual	Motorizado
30 01 60 10	Pivot superior	2	
30 01 60 13	Pivot inferior	2	
30 01 60 19	Casquilho nylon E20	4	
30 01 60 40	Topo PO-11 + PO-22	2	
30 01 60 46	Topo PO-13 + PO-21 E20	4	
30 01 60 52	Topo PO-13	4	
30 01 60 55	Jogo topos inversor PO-20	1	
30 01 60 80	Batente central (manual)	1	-
30 01 60 81	Batente central (motorizado)	-	1
30 01 60 90	Fechadura prumo	1	-
30 01 61 00	Canhão cromado	1	-
30 01 62 00	Junta para inversor		Hp
30 92 22 82	Puxador duplo	1	-
30 92 22 85	Escudo para canhão	2	-
30 95 00 10	Pelúcia Stop-Fin		2Hp
31 01 60 00	Parafuso M8x50 dacromet		48
31 01 60 09	Calço de aperto		12

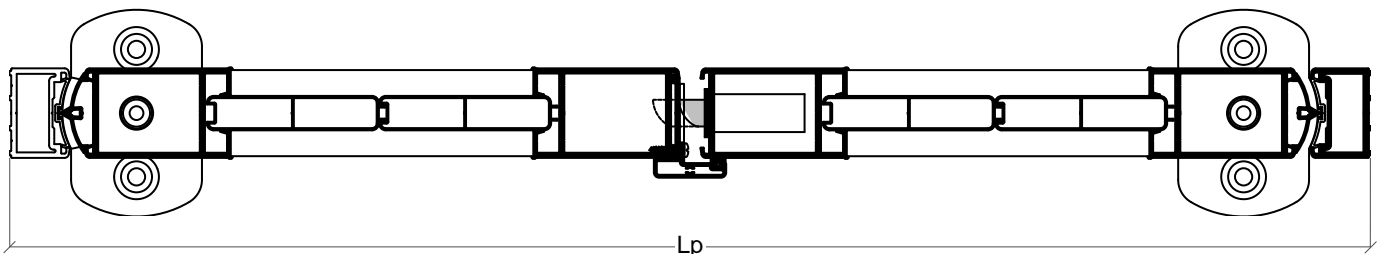

## Portão de Correr com Roletos Especiais

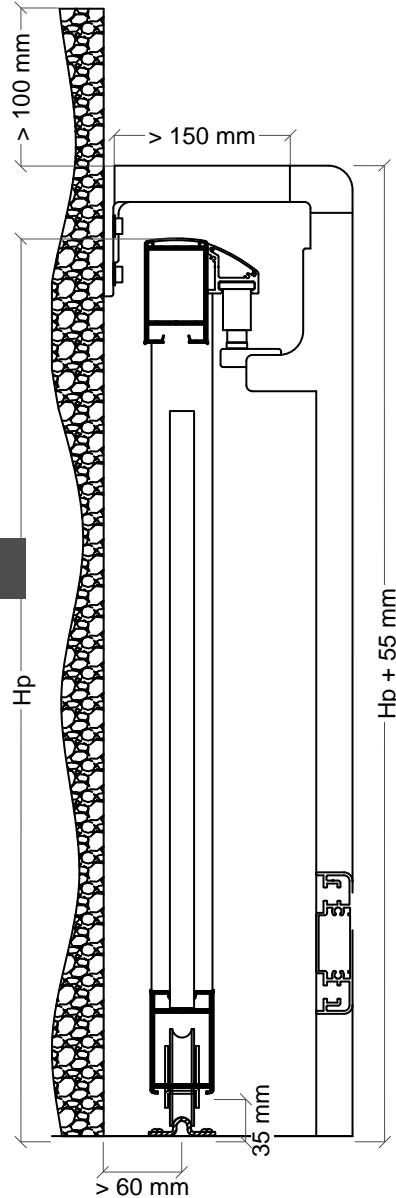
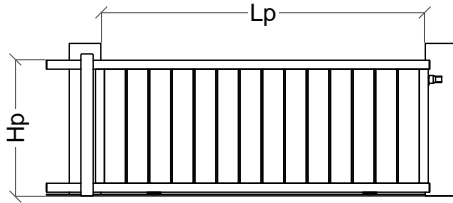

### Perfis

Desenho	Ref	Descrição	Corte	Quant	Medida	
					Manual	Motorizado
	PO-13	Perfil para travessas		2	Lp+200 mm	Lp+500 mm
	PO-14	Tampa superior		2	Lp+200 mm	Lp+500 mm
	PO-16	Perfil para prumos		2	Hp-206 mm	
	PO-18	Ponte para roletos especiais		1	Hp+16 mm	
	PO-18	Ponte para roletos especiais		1	>150 mm	
	PO-19	Guia para roletos especiais		1	Lp+200 mm	Lp+500 mm
	PO-25	Perfil tampa		2	Hp-206 mm	
	PO-25	Perfil tampa		2	160 mm	400 mm
	W-12	Lâmina de 200 mm		várias	Hp-178 mm	
	W-16	Lâmina de 20 mm		várias	Hp-178 mm	

### Acessórios e Juntas

Referência	Descrição	Quantidade	
		Manual	Motorizado
30 01 60 52	Topo PO-13	4	
30 01 60 64	Jogo topos PO-19	1	
30 01 60 96	Fechadura semi-automática	1	-
30 01 61 00	Canhão	1	-
30 01 61 21	Roda com suporte inferior	2 (Lp>4000 mm = 4)	
30 01 61 26	Calha de aço em U (6 mts)	Lp x 2 + 500 mm	
30 01 61 27	União para calha	1	
30 01 61 30	Fixador para PO-18	1	
30 01 61 33	Fixador interior para PO-18	1	
30 01 61 34	Ângulo para PO-18	1	
30 01 61 37	Suporte regulável para roletos	2	
30 01 61 50	Conjunto fecho correr	1	
30 01 61 53	Engate para fecho correr	-	1
30 01 61 56	Gache fecho correr	1	-
30 01 61 57	Batente correr	1	
30 92 22 82	Puxador duplo	1	-
30 92 22 85	Escudo para canhão	2	-
31 01 60 00	Parafuso M8x50	16	
31 01 60 02	Jogo parafuso M5x45	1	-
31 01 60 03	Jogo parafuso M5	1	-
31 01 60 04	Jogo separador 714	1	-
31 01 60 09	Calço de alumínio	4	

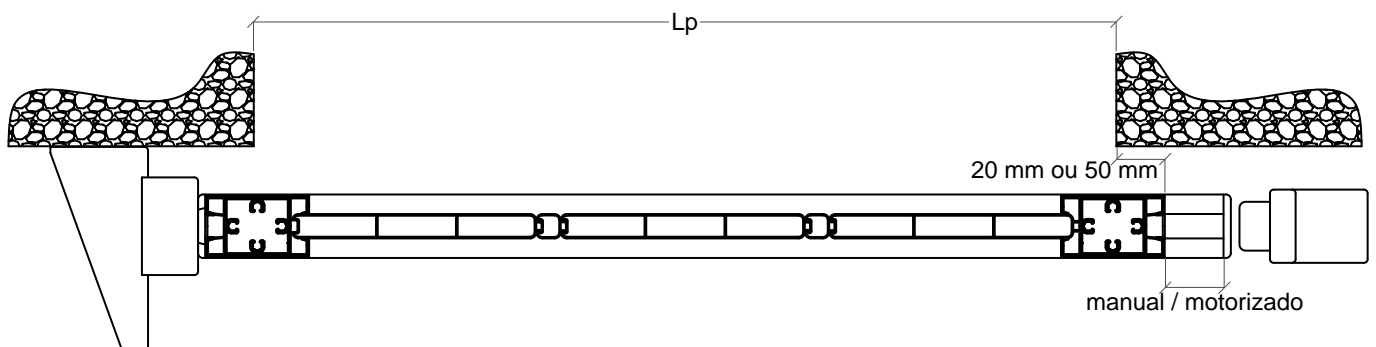

## Portão de Correr com Roletos de 30 mm

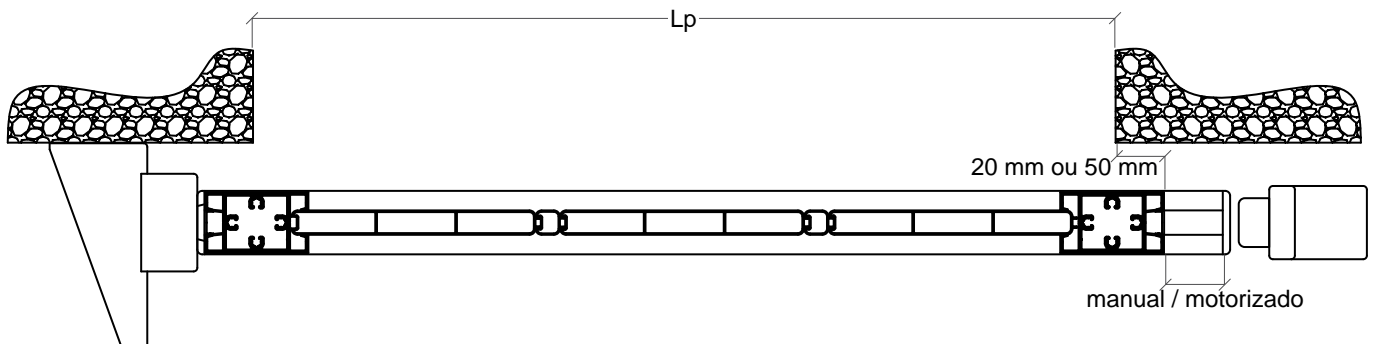
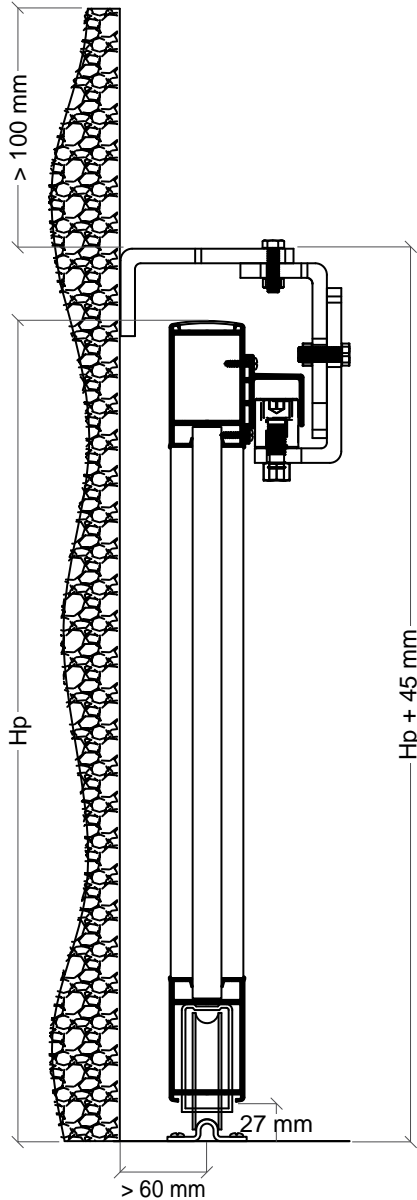
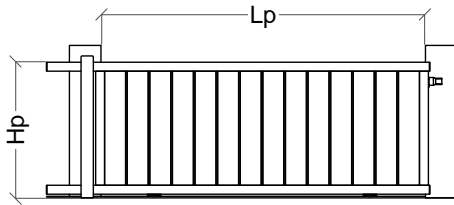

### Perfis

Desenho	Ref	Descrição	Corte	Quant	Medida	
					Manual	Motorizado
	PO-13	Perfil para travessas		2	Lp+200 mm	Lp+500 mm
	PO-14	Tampa superior		1	Lp+200 mm	Lp+500 mm
	PO-16	Perfil para prumos		2	Hp-198 mm	
	PO-09	Guia para roletos 30 mm		1	Lp+200 mm	Lp+500 mm
	PO-25	Perfil tampa		2	Hp-198 mm	
	PO-25	Perfil tampa		2	160 mm	400 mm
	W-12	Lâmina de 200 mm		várias	Hp-170 mm	
	W-16	Lâmina de 20 mm		várias	Hp-170 mm	

### Acessórios e Juntas

Referência	Descrição	Quantidade	
		Manual	Motorizado
30 01 60 52	Topo PO-13	4	
30 01 60 96	Fechadura semi-automática	1	-
30 01 61 00	Canhão	1	-
30 01 61 20	Roda com suporte triangular	2 (Lp>4000 mm = 4)	
30 01 61 26	Calha de aço um U (6 mts)	Lp x 2 + 500 mm	
30 01 61 27	União para calha	1	
30 01 61 40	Ponte com roletos 30 mm	1	
30 01 61 50	Conjunto fecho correr	1	
30 01 61 53	Engate para fecho correr	-	1
30 01 61 56	Gache fecho correr	1	-
30 01 61 60	Batente correr alumínio	1	
30 92 22 82	Puxador duplo	1	-
30 92 22 85	Escudo para canhão	2	-
31 01 60 00	Parafuso M8x50	16	
31 01 60 02	Jogo parafuso M5x45	1	-
31 01 60 03	Jogo parafuso M5	1	-
31 01 60 04	Jogo separador 714	1	-
31 01 60 09	Calço de alumínio	4	

## Gradeamento

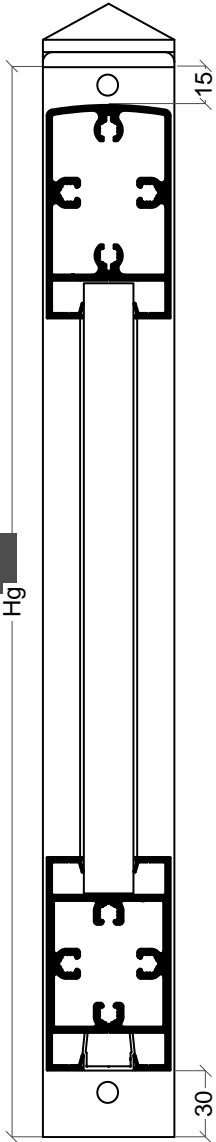
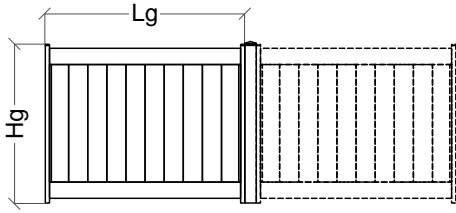

### Perfis

Desenho	Ref	Descrição	Corte	Quant	Medida
	PO-12	Travessa		1	Lg-56 mm
	PO-16	Travessa inferior		1	Lg-56 mm
	PO-23	Remate gradeamento		2	Hg-2 mm
	PO-24	Remate gradeamento		2	Hg
	PO-25	Tampa de remate		1	Lg-56 mm
	W-27	Lâmina		várias	Hg-186 mm
	Q-20	Prumo		1	Hg+6 mm
	U-11	Remate lateral		2	Hg-215 mm

### Acessórios e Juntas

Referência	Descrição	Quantidade
30 01 60 61	Jogo topos reguláveis	2
31 01 61 82	Fixador pavimento	1
30 01 61 70	Topo piramidal 60x60	1
31 01 60 01	Parafuso M8x25 dacromet	8

14

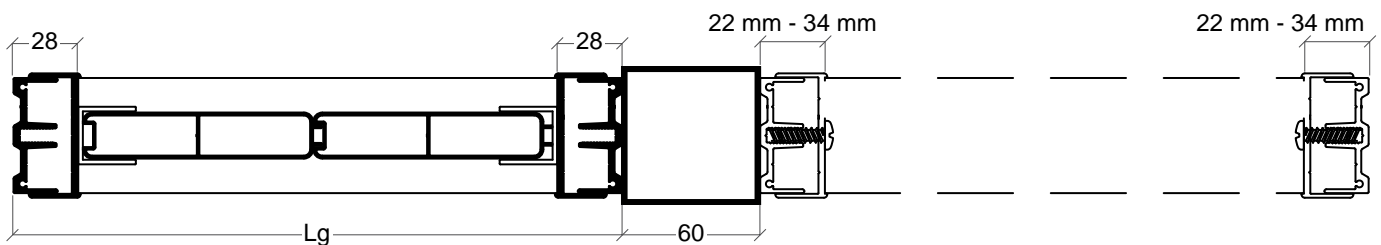

### Exemplos de Tipologias possíveis

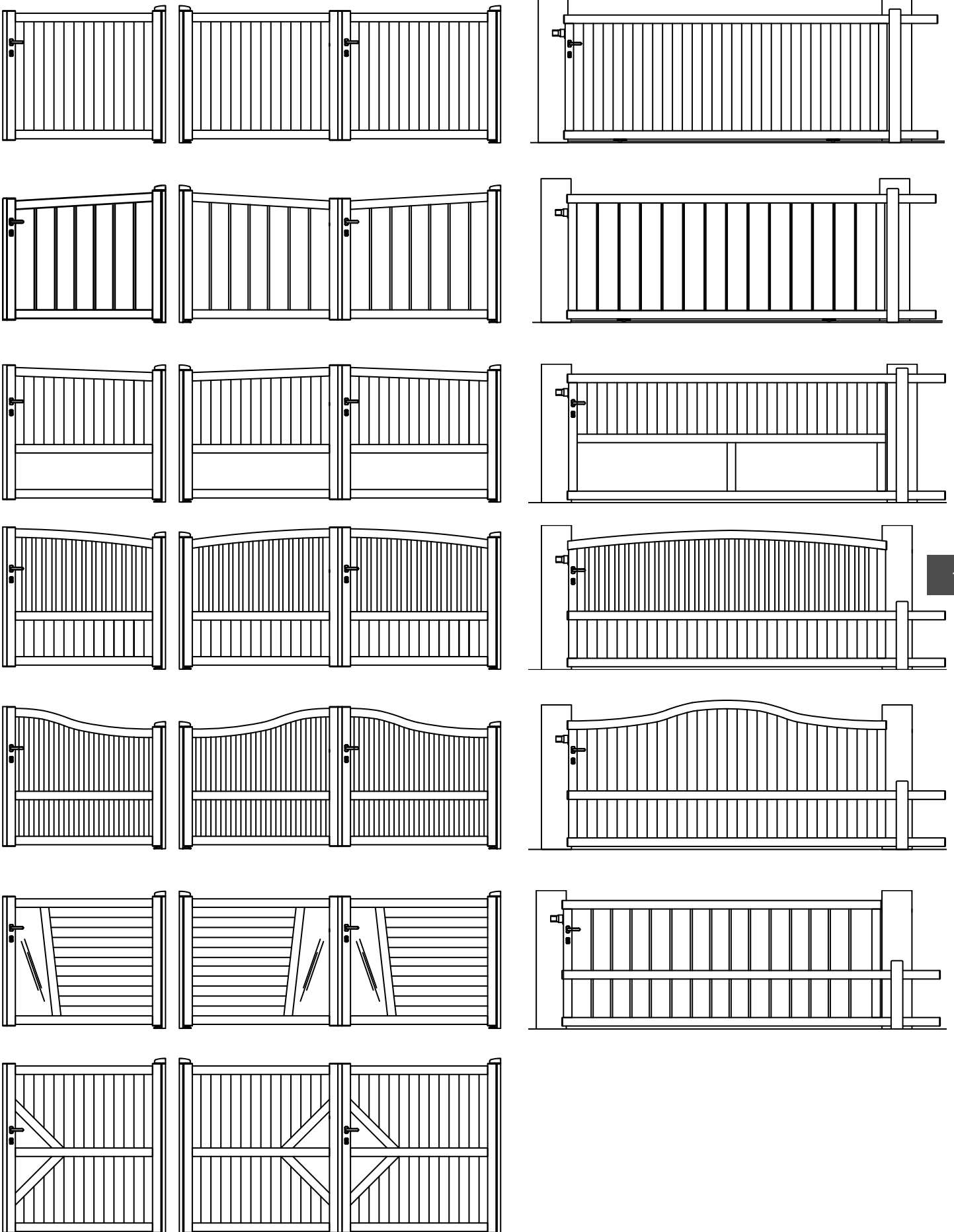

### Pormenores de Montagem

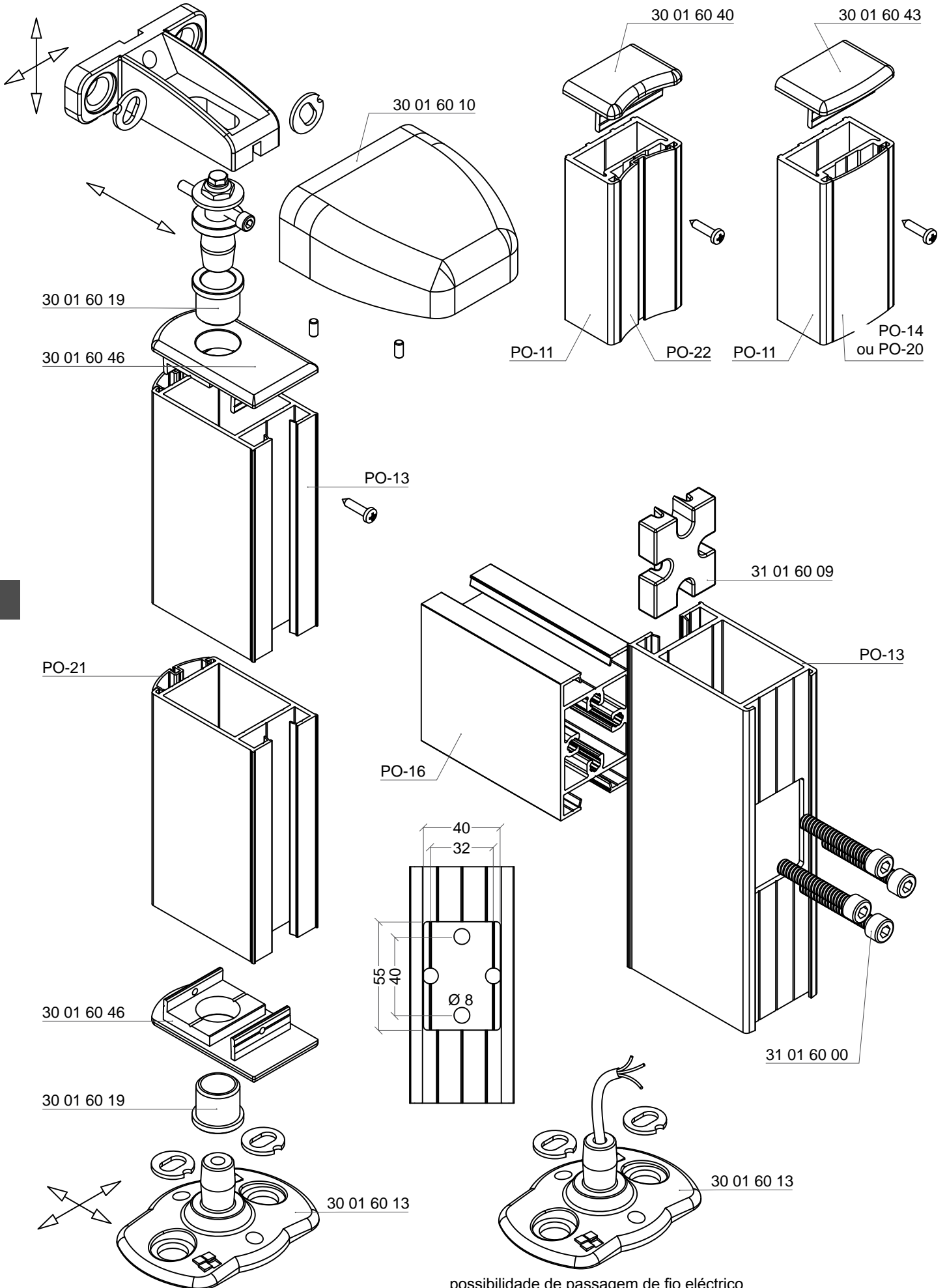



### Pormenores de Montagem

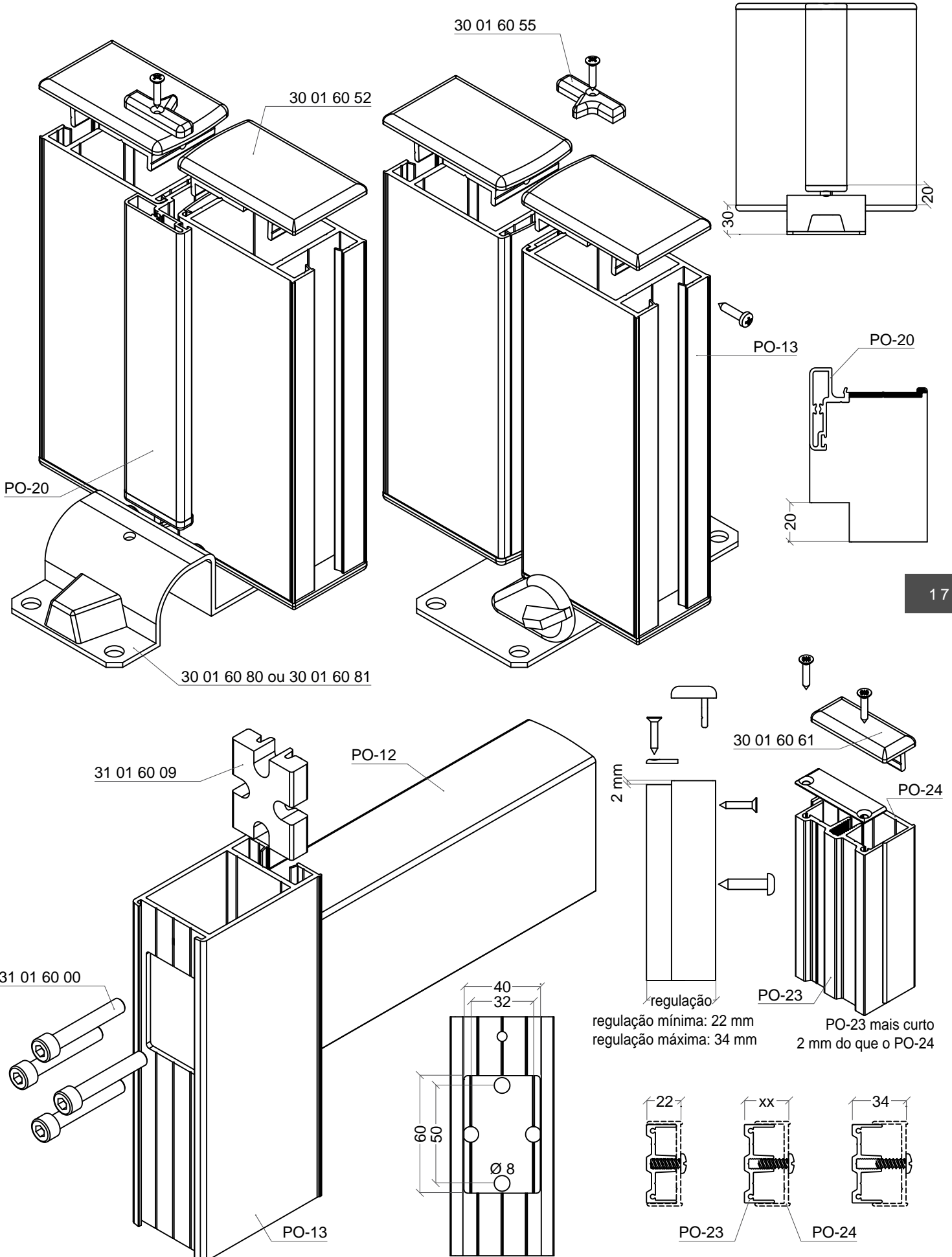

### Pormenores de Montagem

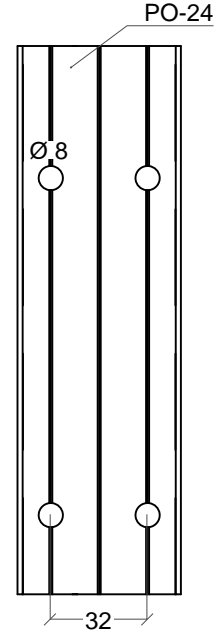
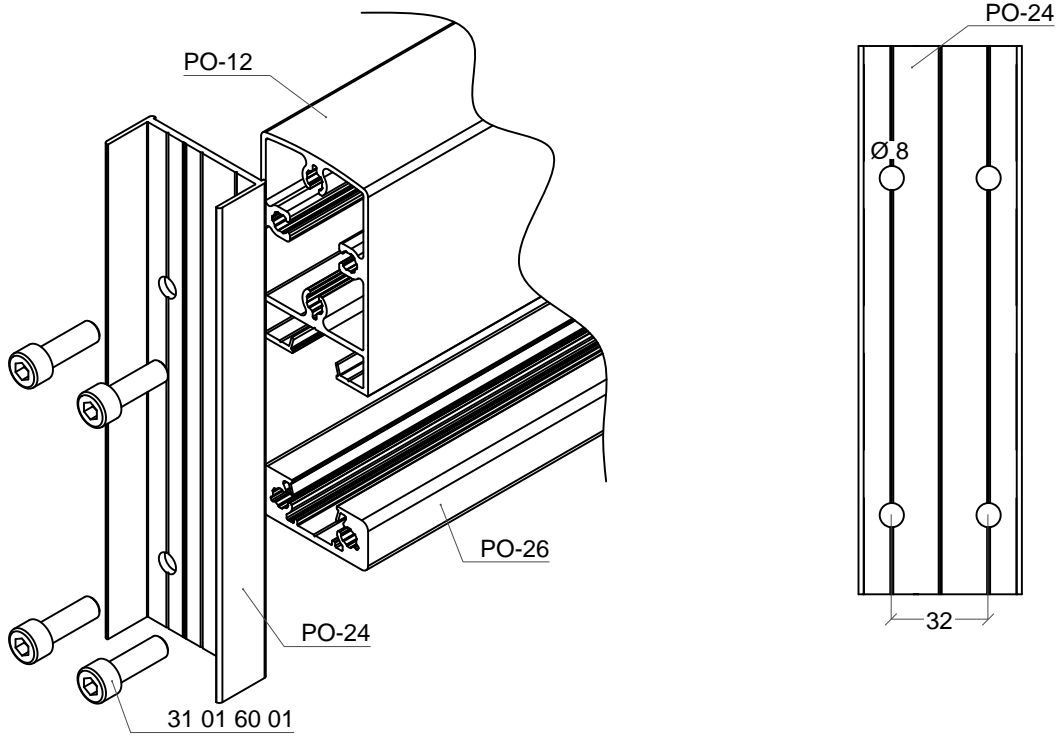

18

